

21+/**FORD BRONCO RAPTOR**

PHANTOM FRONT BUMPER

F260262110103



TOOLS REQUIRED

(Torx) T30, T40
(Allen) 7/32
(Wrench) 10mm, 15mm, 9/16, 3/4
(Socket) 10mm, 15mm, 9/16, 3/4
(Drill Bit) 9/16
Ratchet
Drill
Flat Head/Fastener Remover



SKILL LEVEL

-Easy/Intermediate

****This installation requires 2 people for best results****



TIME REQUIRED

- 4 hours for OEM Removal/Bumper Install
-1 Additional Hour to Wire Lights

****Labor Rates are based on a vehicle with no pre-existing damage. Wiring labor is based on a standard wiring procedure with light switches installed in an easily accessible location. Custom light triggering or switch mounting location will result in a greater labor charge.****



INCLUDED IN KIT

8- 3/8-16 X 1" Button Head Bolt	4- 1/2-13 X 1 1/4" Hex Head Bolt
5- 3/8" Flat Washer	4- 1/2-13" Nylon Lock Nut
5- 3/8-16 Nylon Lock Nut	8- 1/2" Flat Washer
2- 3/8-16 X 1" Carriage Bolt	
2- 3/8-16 X 1" Hex Head Bolt	
2- 3/8" Fender Washer	
2- 3/8-16" Nut Clip	

⚠ WARNINGS/CAUTIONS BEFORE STARTING INSTALLATION ⚠

-BEFORE YOU INSTALL THIS KIT-

Read and understand all instructions, warnings, cautions, & notes contained in this installation instruction guide. Consult your vehicle owner's manual for proper disconnection of electrical and lifting of vehicle if required for installation of this product.

This install may require some technical skills and knowledge of basic mechanical work. If you do not feel that you are capable of performing this install please take this product to a trained professional.

After reading this guide please contact us with any questions or concerns before installing product.
Customer Service (480) 671-0820

Addictive desert designs is *not* responsible for any bodily injury or harm to you or your vehicle as a result of an improper install.

Proper installation of this kit required knowledge of the factory recommended procedures for removal and installation of original equipment components.

We recommend that the factory shop manual and any special tools needed to service your vehicle be on hand during the installation. Installation of this kit without proper knowledge of the factory recommended procedures may affect the performance of these components and the safety of the vehicle.

Inspect all contents of this package to make sure product is not damaged and all installation hardware has been included. If parts are missing from kit, please be prepared to provide the following information:

1. Name of purchase location
2. Bar Code on side of box
3. Date above bar code
4. Date inside box cover

ALWAYS WEAR EYE PROTECTION WHEN OPERATING POWER TOOLS

PHANTOM FRONT BUMPER 21+/FORD BRONCO RAPTOR

REMOVAL

□ STEP 1

Disconnect the wire harness plug located on the driver side.



PHANTOM FRONT BUMPER 21+/FORD BRONCO RAPTOR

REMOVAL

□ STEP 2

Remove the skid plate using a (15mm socket). ****Keep these for they will be used later on in the install****



PHANTOM FRONT BUMPER 21+/FORD BRONCO RAPTOR

REMOVAL

□ STEP 3

Remove all the push pins for the front cover using a (fastener remover/flathead).

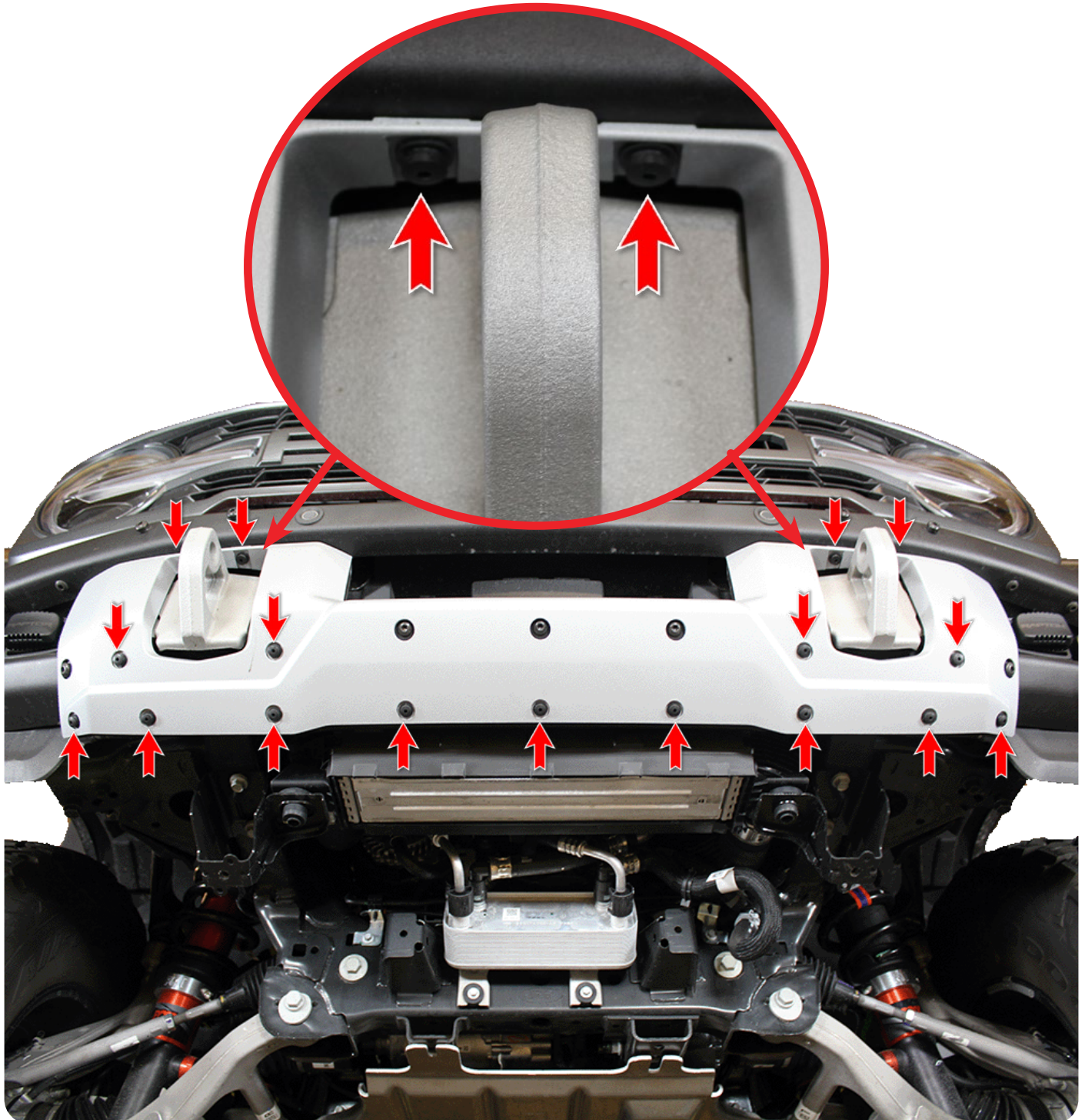

PHANTOM FRONT BUMPER 21+ / FORD BRONCO RAPTOR

REMOVAL

□ STEP 4

Remove the mounting bolts located on the tow hooks using a (15mm socket). You can now remove the bumper.



PHANTOM FRONT BUMPER 21+/FORD BRONCO RAPTOR

REMOVAL

❑ STEP 5

(If equiped) Follow the ACC install guide before continuing with the install.

<https://cdn.shopify.com/s/files/1/0627/4508/4140/files/2021-ford-bronco-cruise-control-install.pdf?v=1654182892>

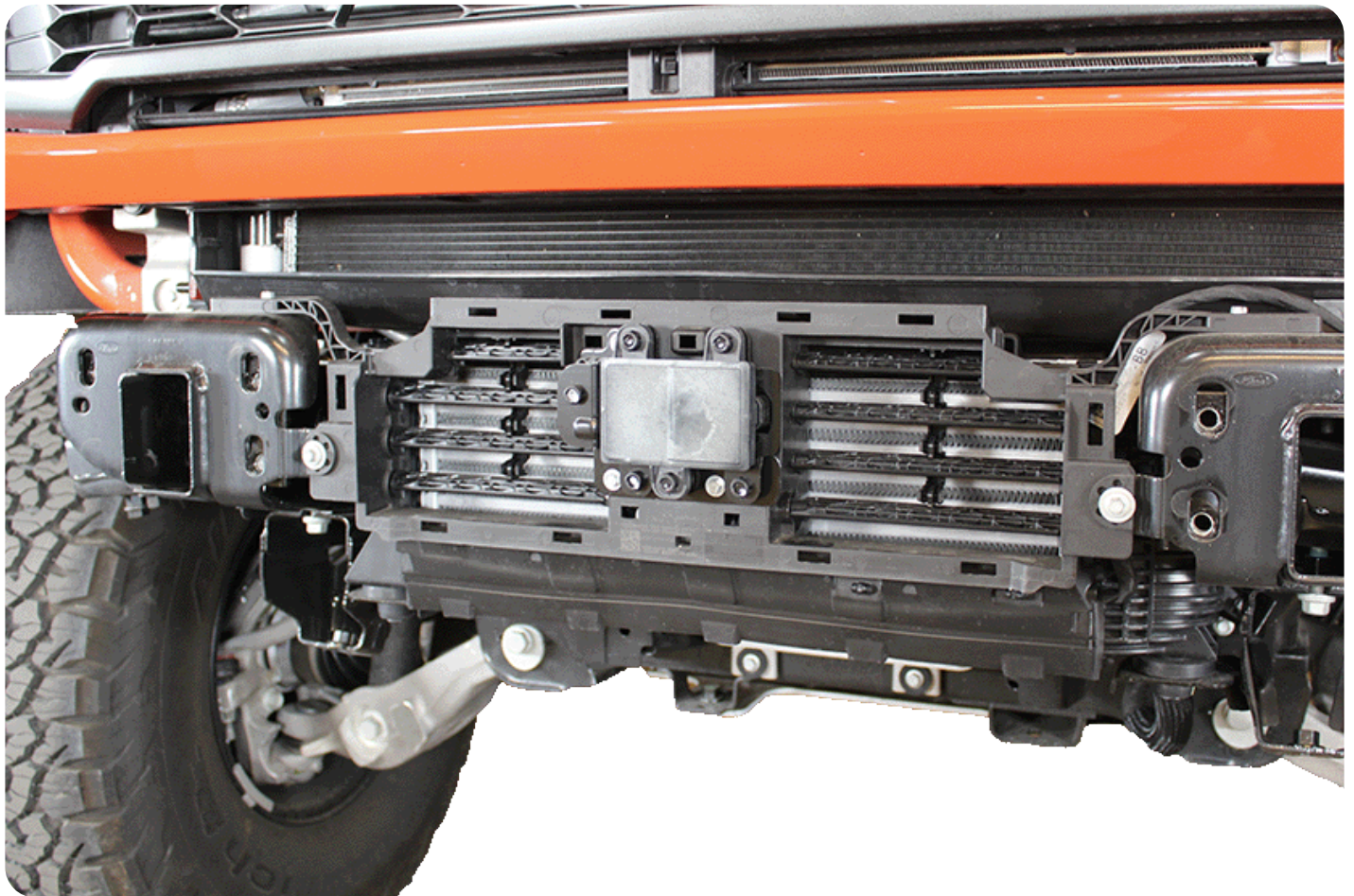

PHANTOM FRONT BUMPER 21+/FORD BRONCO RAPTOR

REMOVAL

□ STEP 6

Remove the mounting bracket plastic nuts located behind the frame horns. There are 2x on each side.



PHANTOM FRONT BUMPER 21+ / FORD BRONCO RAPTOR

REMOVAL

□ STEP 7

Remove the plastic covers on each outer sides using a (fastener remover/flathead).

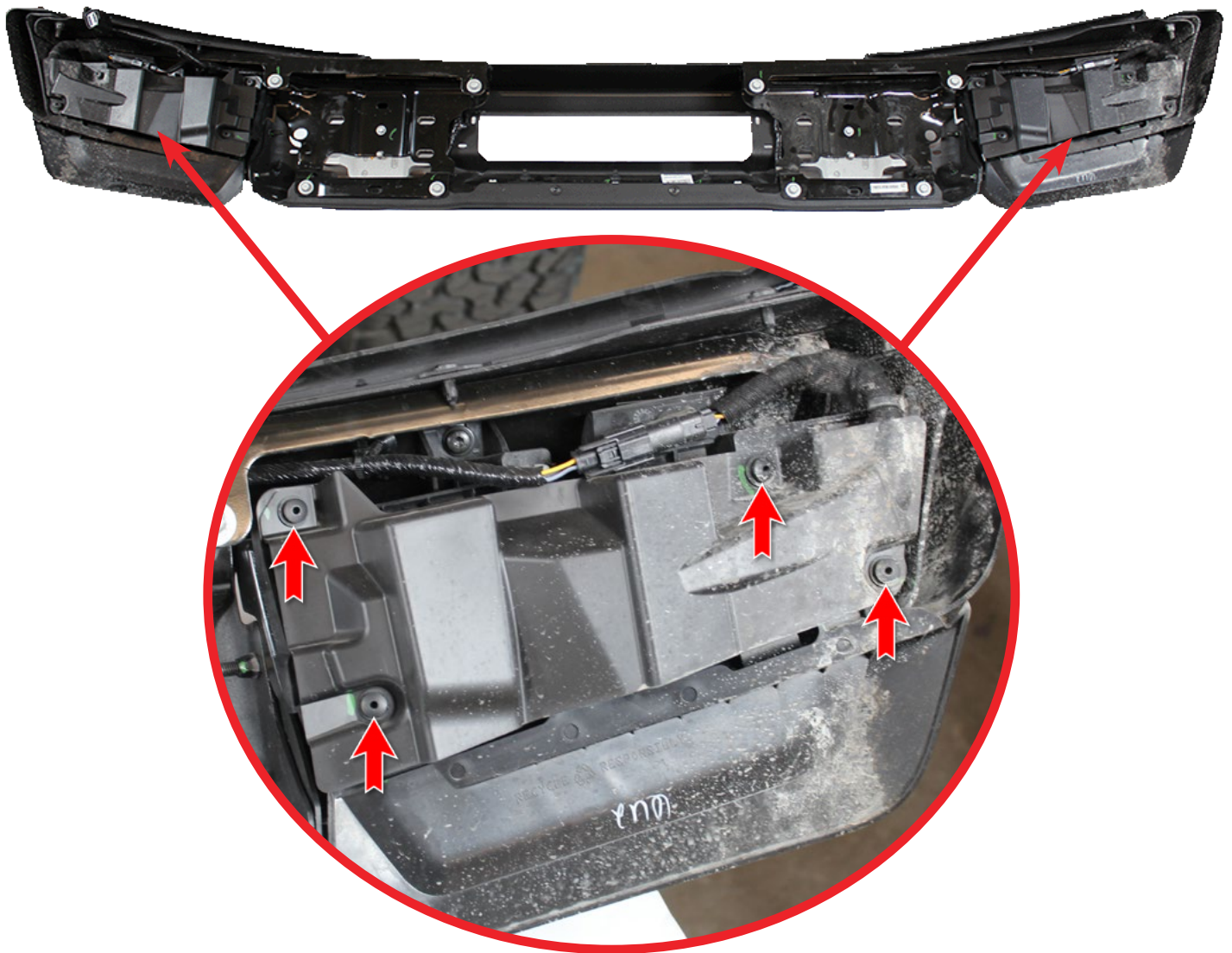

PHANTOM FRONT BUMPER 21+ / FORD BRONCO RAPTOR

REMOVAL

□ STEP 8

Next, Remove the 4x bolts holding the light brackets using a (T30). Then disconnect the plug located above the lights.

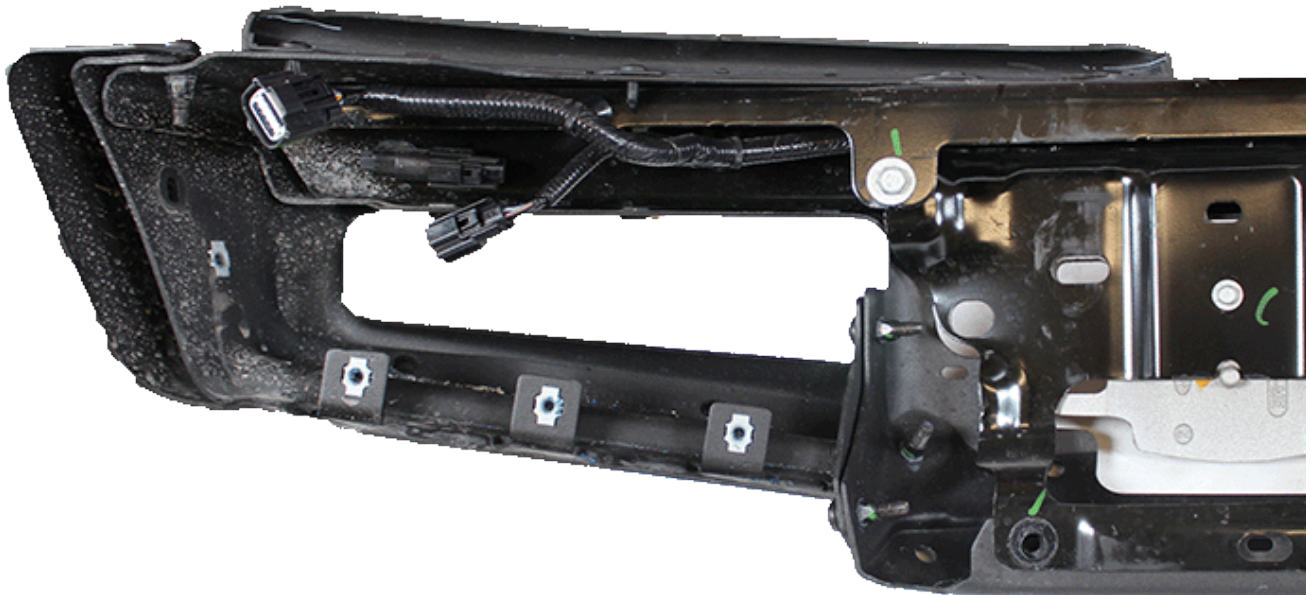
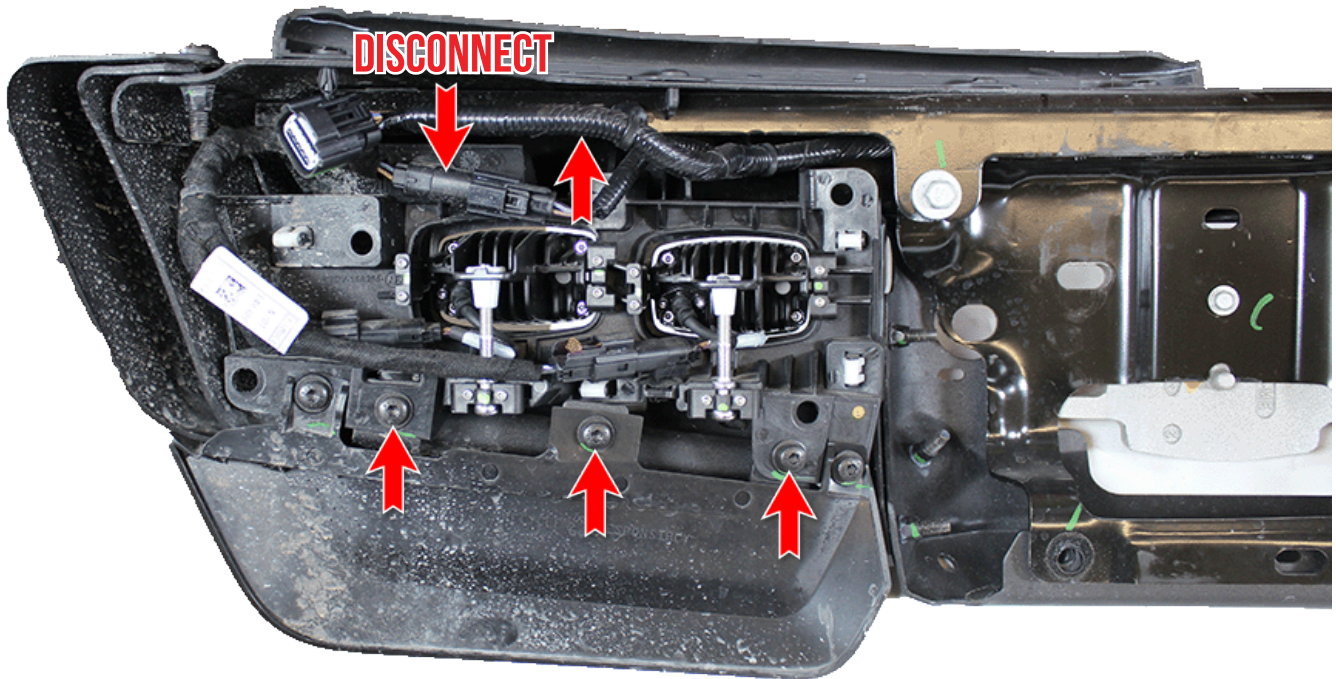

PHANTOM FRONT BUMPER 21+ / FORD BRONCO RAPTOR

REMOVAL

□ STEP 9

Remove the tow hook brackets using a (10mm socket).

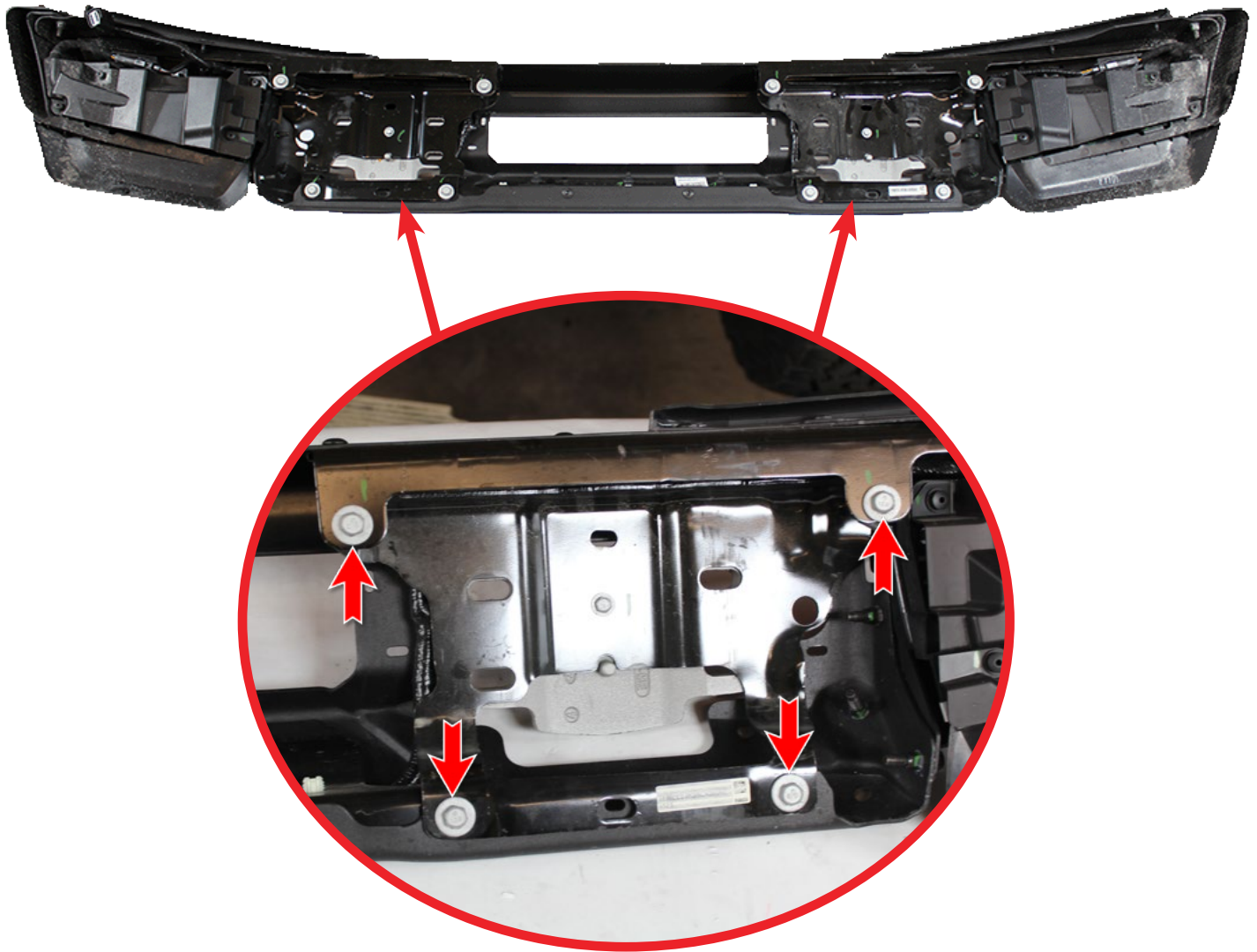

PHANTOM FRONT BUMPER 21+ / FORD BRONCO RAPTOR

REMOVAL

□ STEP 10

Remove the 5x bolts holding the middle plate using a (T40).

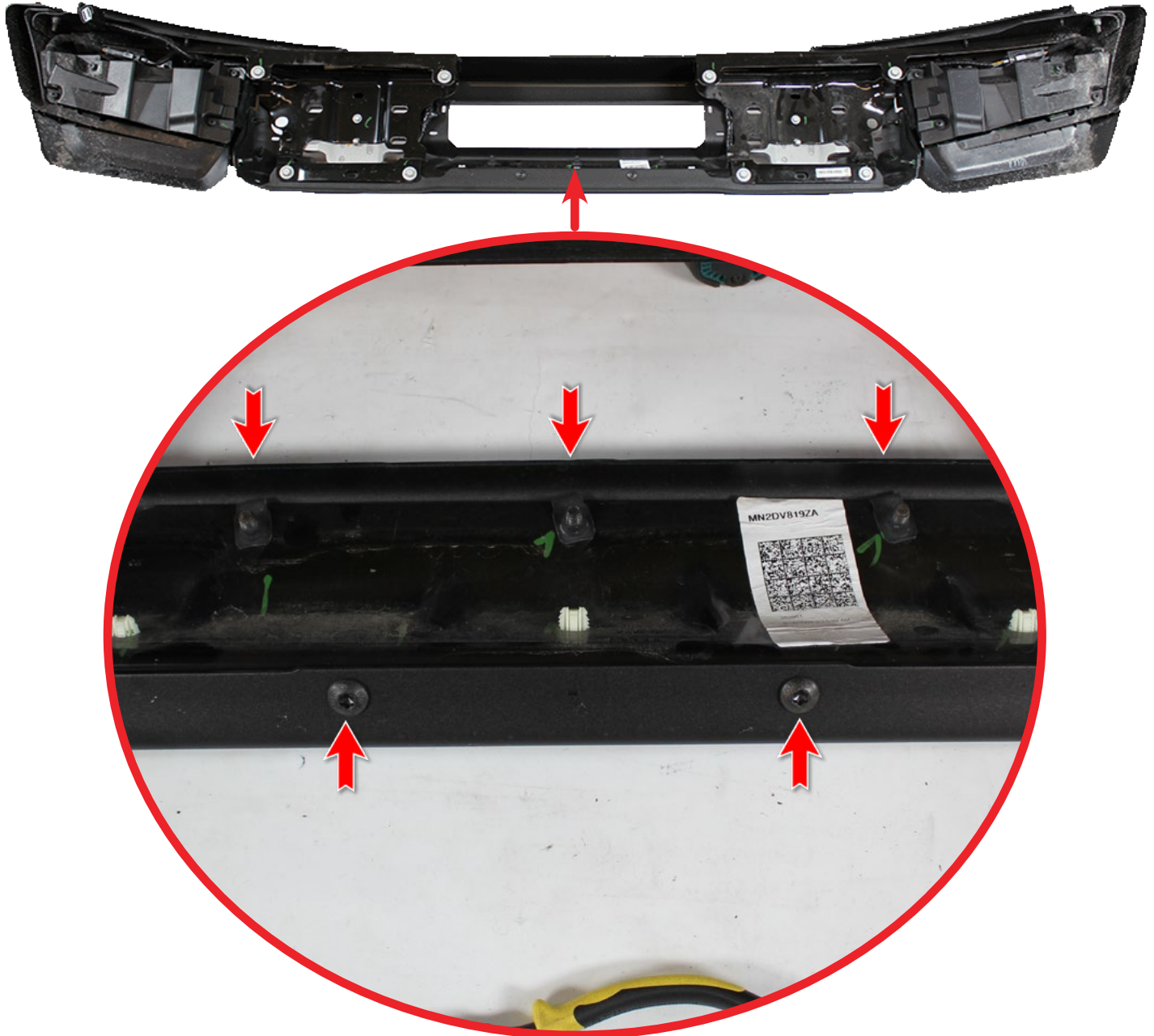

PHANTOM FRONT BUMPER 21+ / FORD BRONCO RAPTOR

REMOVAL

□ STEP 11

Remove all of the front and top face bolts that are indicated below using a (T40).



PHANTOM FRONT BUMPER 21+ / FORD BRONCO RAPTOR

REMOVAL

□ STEP 12

You can now remove the wire harness by removing the sensors and sensor bezels by follow the images below. ****Remember the orientation for this will be important in step 13****

**SPREAD THE TABS ON EACH SIDE
OF THE SENSOR TO RELEASE IT AND
PULL OUT**

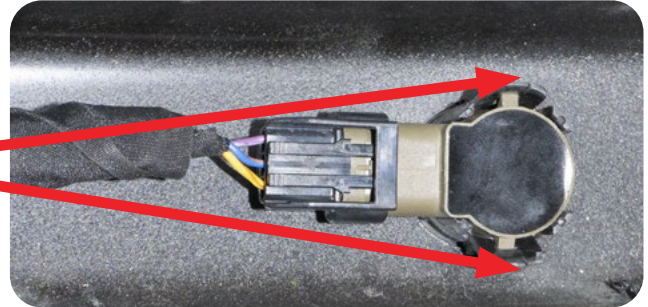

**SQUEEZE TOGETHER ON THE
INSIDE OF THE BUMPER THEN
PUSH OUT**



PHANTOM FRONT BUMPER 21+/FORD BRONCO RAPTOR

INSTALL

□ STEP 13

Install the sensor bezels into the ADD bumper. Ensure they are in the same orientation as OEM.
****If the bezels do not click into place you may have to trim the tabs to match the thickness of the bumper as shown below****

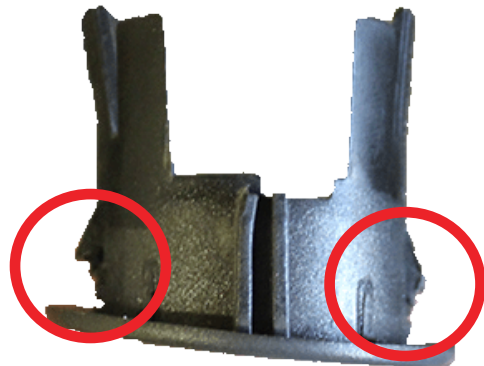
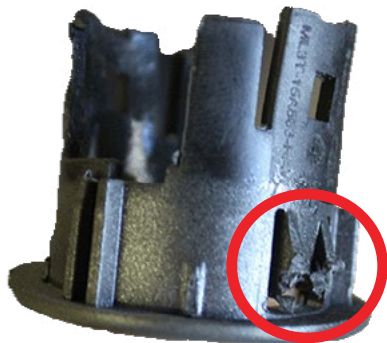
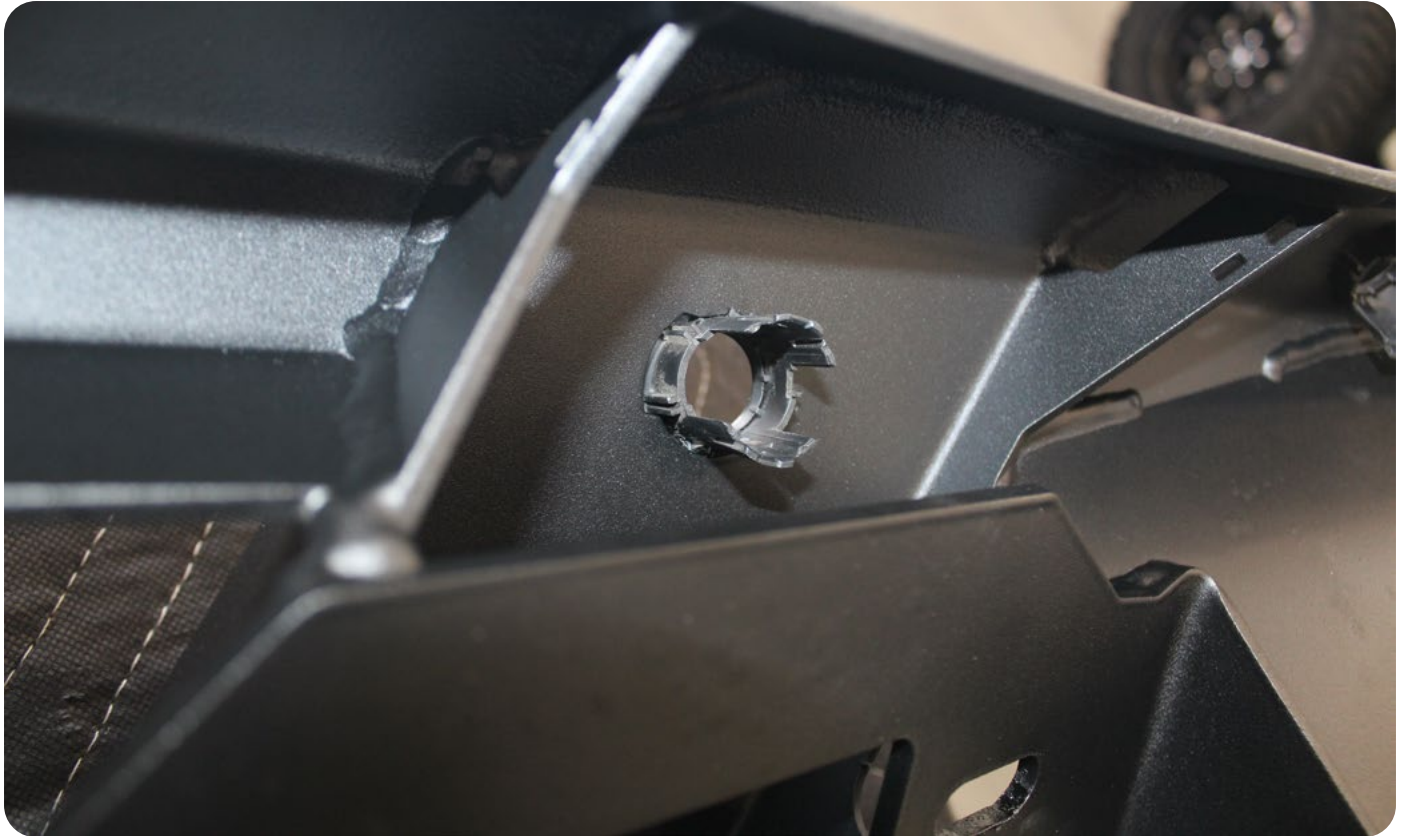

PHANTOM FRONT BUMPER 21+ / FORD BRONCO RAPTOR

INSTALL

□ STEP 14

Install the U-nut clips in the provided mounting slots.

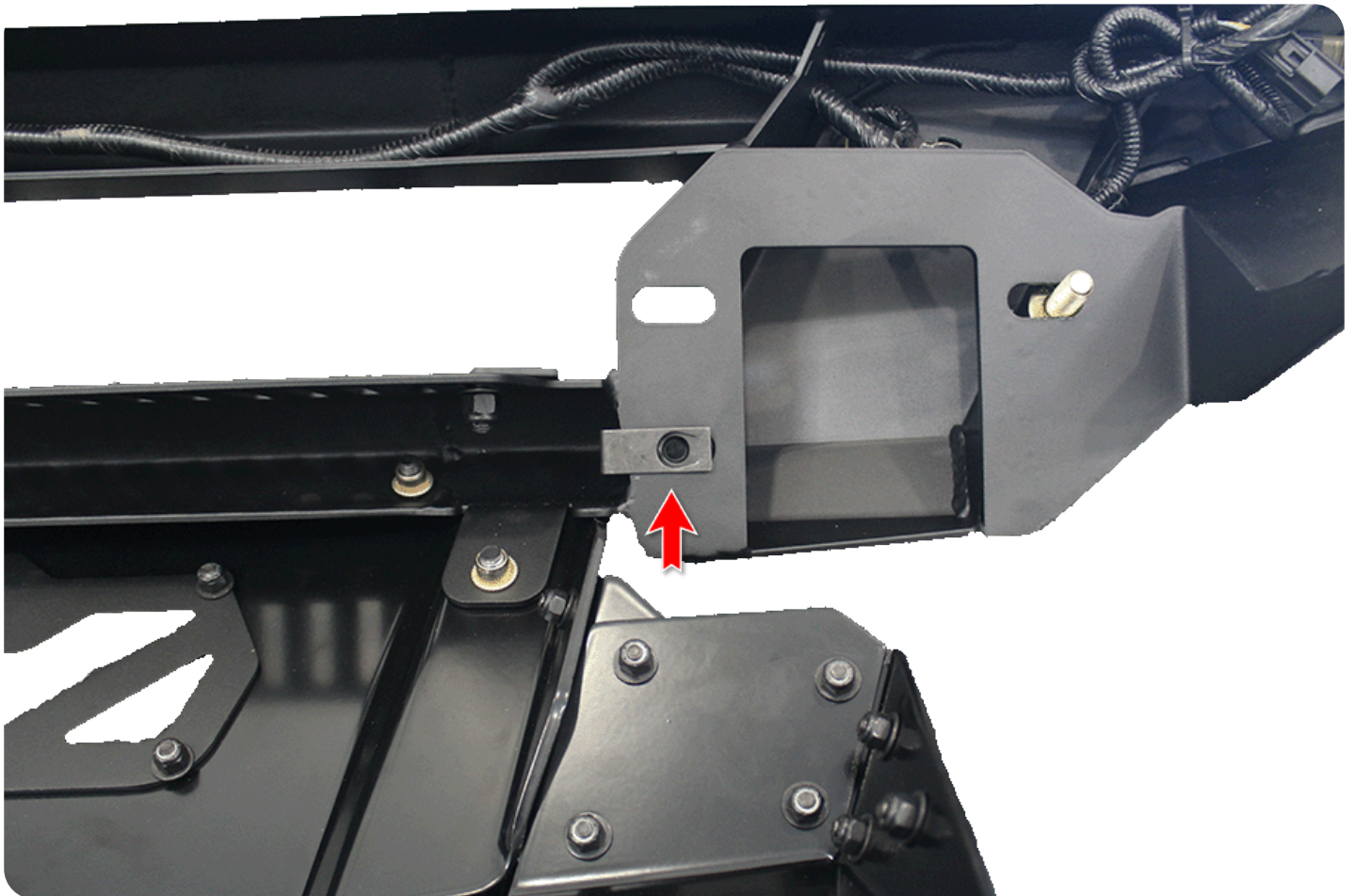

PHANTOM FRONT BUMPER 21+ / FORD BRONCO RAPTOR

INSTALL

□ STEP 15

Assemble the skid plate bottom mount to the skid plate using the provided 3/8" button head bolts, washers, nylon lock nuts with a (7/32 allen wrench) and (9/16 wrench).

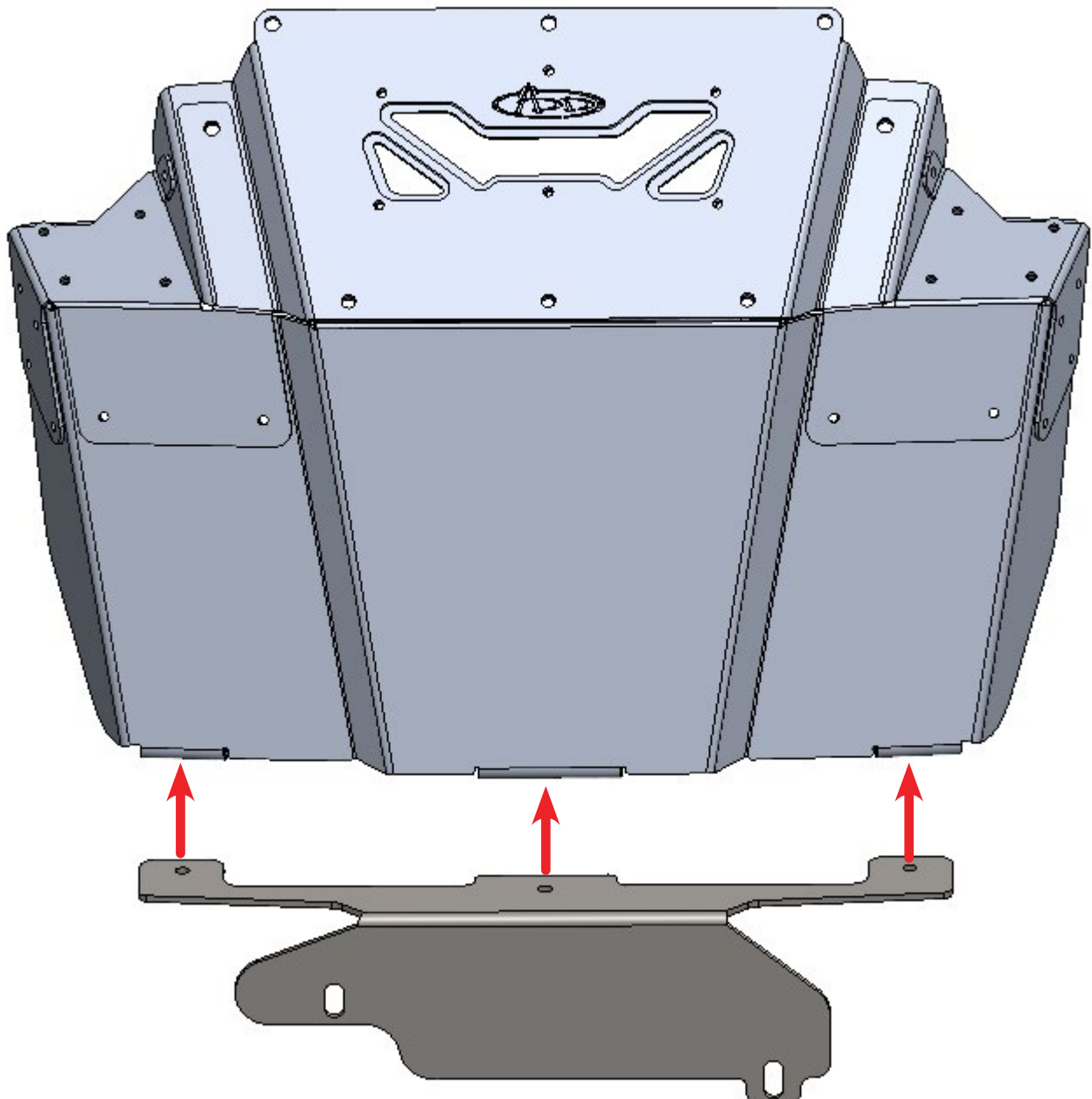

PHANTOM FRONT BUMPER 21+ / FORD BRONCO RAPTOR

INSTALL

□ STEP 16

Remove the OEM inner cooler brackets **one at a time** using a (15mm socket) and install the provided brackets using the same OEM hardware.



PHANTOM FRONT BUMPER 21+ / FORD BRONCO RAPTOR

INSTALL

□ STEP 17

(OPTIONAL) If you wish to use the factory OEM tow hooks, Remove the OEM tow hooks from the rear and follow the steps below. **(Ensure when you mark the holes the tow hook is against the inner cooler bracket installed on step 16)** **HARDWARE NOT INCLUDED**

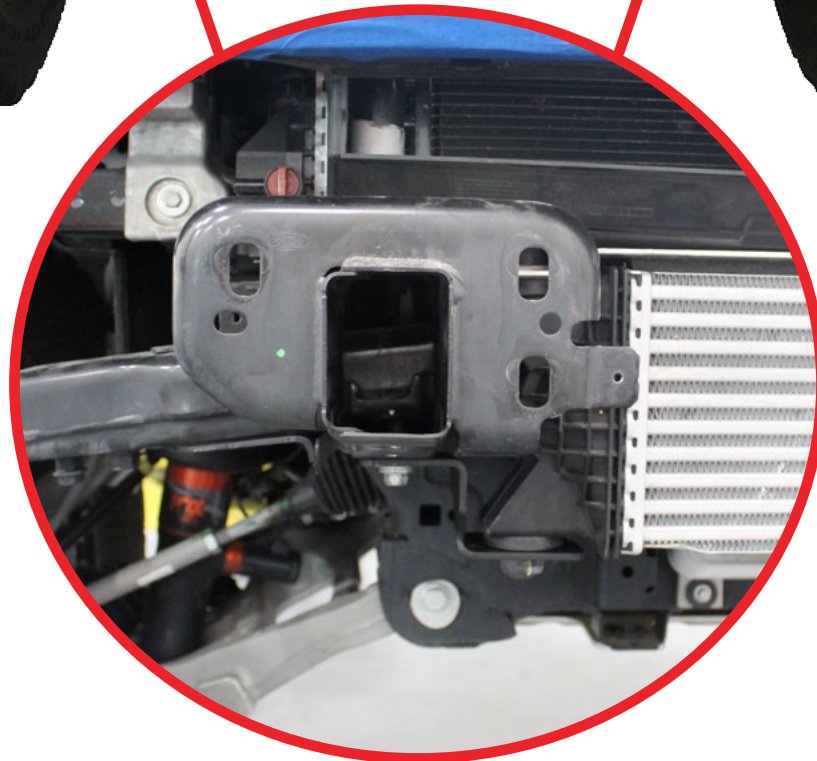
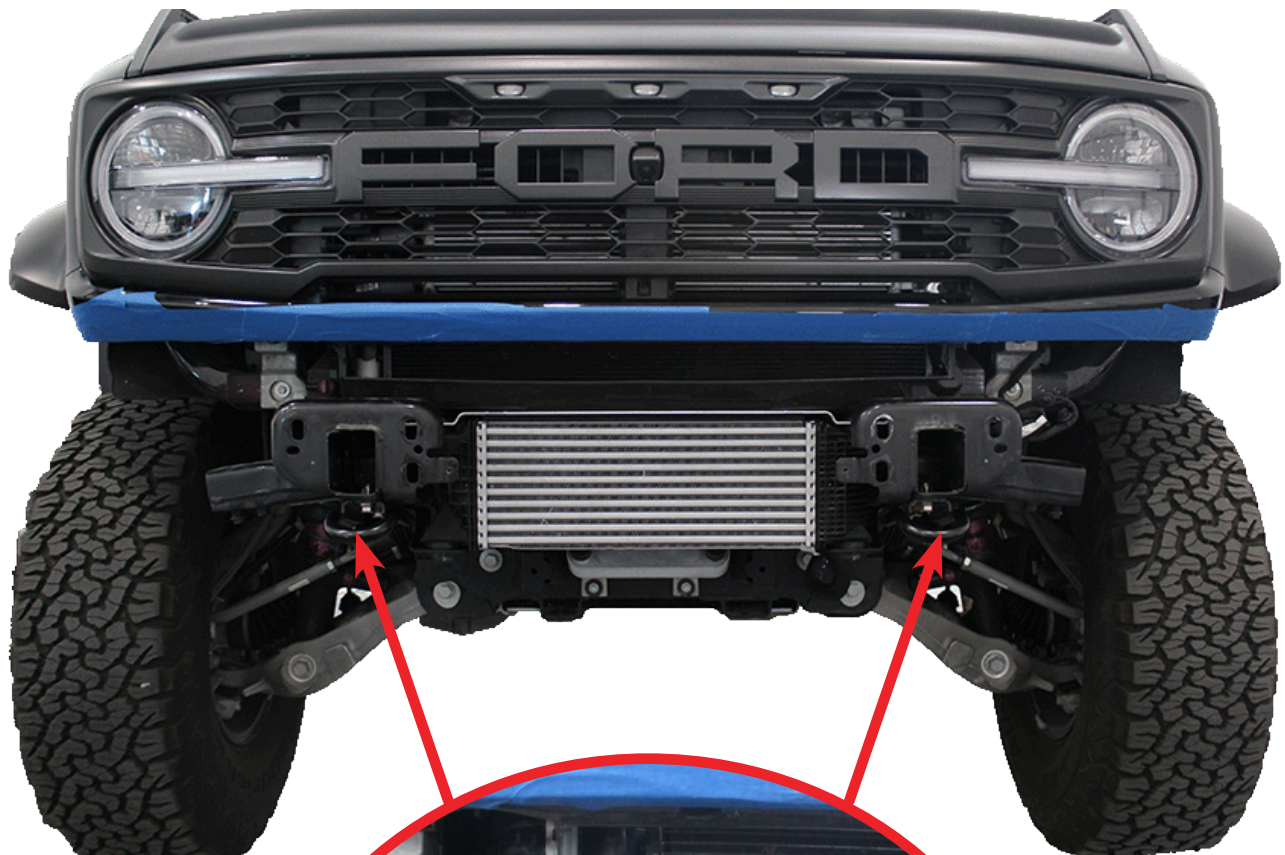

PHANTOM FRONT BUMPER 21+/FORD BRONCO RAPTOR

INSTALL

MARK HOLES

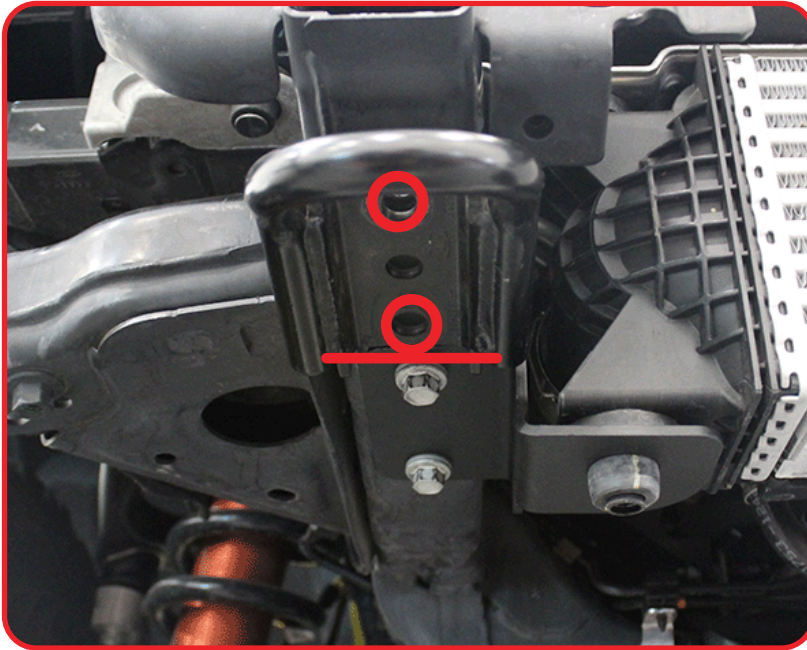

DRILL

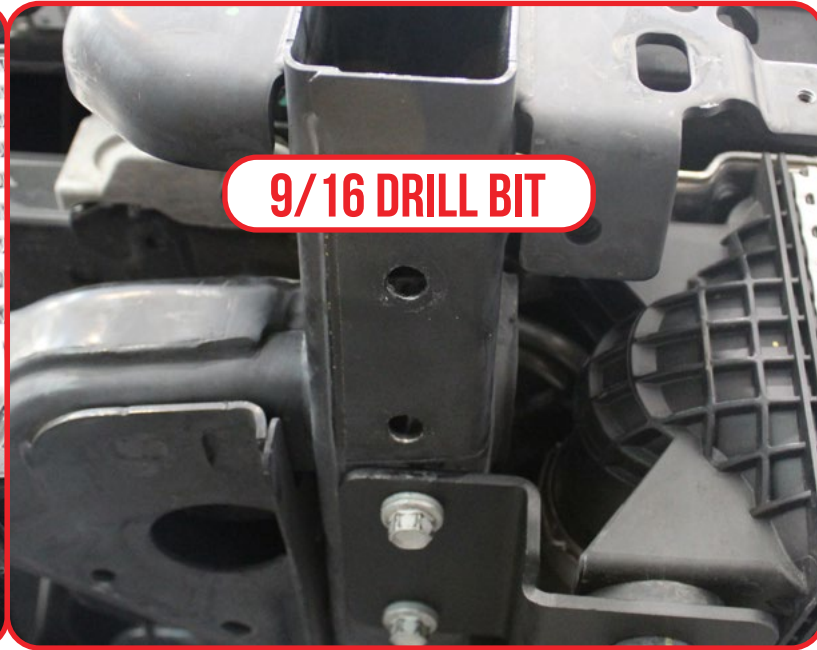

THROUGH BOLT



TIGHTEN



HARDWARE

- (X4) 1/2-13 X 1 1/4 HEX HEAD BOLT GRADE 8
- (X4) 1/2-13 NYLON LOCK NUT
- (X8) 1/2 FLAT WASHER

PHANTOM FRONT BUMPER 21+ / FORD BRONCO RAPTOR

INSTALL

□ STEP 18

You can now install the bumper **without** the skid plate with the 4x provided 1/2" hex head bolts, and washers using a (3/4 socket/wrench) and the 2x provided 3/8" hex head bolts and fender washers with a (9/16 socket).



PHANTOM FRONT BUMPER 21+ / FORD BRONCO RAPTOR

INSTALL

□ STEP 19

You can now install the skid plate using the provided 3/8 button head bolts using a (7/32 allen) and install the OEM skid hardware removed from **step 2** on the bottom using a (15mm socket).



PHANTOM FRONT BUMPER 21+ / FORD BRONCO RAPTOR

FINAL

- Stand back and enjoy your new ADD Phantom™ Front Bumper.
Check and re-tighten, if needed, all mounting bolts after 100 miles and periodically thereafter.



THIS PRODUCT IS PROTECTED BY ONE OR MORE U.S. PATENTS
WWW.ADDICTIVEDESERTDESIGNS.COM/PATENTS

FOR ADDITIONAL SUPPORT OR TECHNICAL QUESTIONS,
PLEASE CALL 480-671-0820 OR
EMAIL INFO@ADDICTIVEDESERTDESIGNS.COM