



# INSTALLATION INSTRUCTIONS

## MID-FRAME BUMPER

Part Number: 95895

Application: 2015 Ram 2500/3500

### GENERAL SAFETY PRECAUTIONS

Your safety, and the safety of others, is very important. To help you make informed decisions about safety, we have provided installation and operating instructions and other information on labels and in this guide. This information alerts you to potential hazards that could hurt you or others. It is not possible to warn you about all potential hazards associated with this product, you must use your own good judgment.

**CARELESS INSTALLATION AND OPERATION CAN RESULT IN SERIOUS INJURY OR EQUIPMENT DAMAGE. READ AND UNDERSTAND ALL SAFETY PRECAUTIONS AND OPERATING INSTRUCTIONS BEFORE INSTALLING AND OPERATING THIS PRODUCT.**

This guide identifies potential hazards and has important safety messages that help you and others avoid personal injury or death. WARNING and CAUTION are signal words that identify the level of hazard. These signal words mean:

▲WARNING signals a hazard that could cause serious injury or death, if you do not follow recommendations. ▲CAUTION signals a hazard that may cause minor to moderate injury, if you do not follow recommendations.

This guide uses NOTICE to call attention to important mechanical information, and Note: to emphasize general information worthy of special attention.

### ▲ WARNING

#### IMPACT AND MOVING PARTS ENTANGLEMENT HAZARD

Failure to observe these instructions could lead to severe injury or death

- **Always** take time to fully read the Instructions and/or Operations Guide, and/or Basic Guide to Winching Techniques, in order to understand your winch and its operations.
- **Always** use extreme caution when drilling on any vehicle. Make sure that all fuel lines, brake lines, electrical wires, and other objects are not punctured or damaged when/if drilling on the vehicle. Thoroughly inspect the area to be drilled (on both sides of material) prior to drilling, and relocate any objects that may be damaged. Failure to inspect the area to be drilled may result in vehicle damage, electrical shock, fire or personal injury.
- **Always** wear safety glasses when installing this kit. A drilling operation will cause flying metal chips. Flying chips can cause eye injury.
- **Always** use extreme caution when cutting and trimming during fitting.
- **Always** remove jewelry and wear eye protection.
- **Never** lean over battery while making connections.
- **Never** route electrical cables:
  - o Across any sharp edges.
  - o Through or near moving parts.
  - o Near parts that become hot.
- **Always** insulate and protect all exposed wiring and electrical terminals.
- **Always** install terminal boots as directed in installation instructions.
- **Always** use appropriate and adequate care in lifting components into place.
- **Always** insure components will remain secure during installation and operation.
- **Always** tighten all nuts and bolts securely, per the installation instructions.
- **Always** perform regular inspections and maintenance on the plow mechanism, fasteners, cable and related hardware.
- **Always** replace all worn or damaged parts before operating.
- **Never** operate this WARN product with damaged or missing parts.

Read installation and operating instructions thoroughly.

WARN INDUSTRIES, INC. 12900 S.E. Capps Road,  
Clackamas, OR USA 97015-8903, 1-503-722-1200, FAX: 1-503-722-3000  
Customer Service: 1-800-543-9276  
Dealer Locator Service: 1-800-910-1122  
International Fax: 1-503-722-3005

## ⚠ CAUTION

### MOVING PARTS ENTANGLEMENT HAZARD

Failure to observe these instructions could lead to minor or moderate injury

- **Always** take time to fully read and understand the installation and Operations Guide included with this product.
- **Never** operate this product if you are under 16 years of age.
- **Never** operate this product when under the influence of drugs, alcohol or medications.

Read installation and operating instructions thoroughly.

## NOTICE

### EQUIPMENT DAMAGE

- **Always** refer to the Installation and Specification Guide, supplied in the winch kit, for all wiring schematics and specific details on how to wire this WARN product to your vehicle.

Read installation and operating instructions thoroughly.

## BEFORE YOU BEGIN

## NOTICE

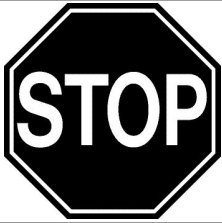

This product may interfere with driver assist systems such as adaptive cruise control and parking assist systems that have sensors or cameras installed in the bumpers or front grill area. If your vehicle is equipped with any of these systems or features, consult your vehicle owner's manual before installing this product. These systems may need to be disabled as a result of installing this product.

## TABLE OF CONTENTS

Tools Required.....	page 2
Torque Specifications.....	page 2
Parts List.....	page 3
Installation.....	page 4-9
Maintenance/Care.....	page 10

## TOOLS REQUIRED

- Standard wrenches
- Standard sockets

## TORQUE SPECIFICATIONS

Please use the recommended torque specifications when assembling this product unless otherwise specified in the instructions.

FASTENER SIZE	FASTENER TORQUE		FASTENER SIZE	FASTENER TORQUE	
	lb-ft	(N.m)		lb-ft	(N.m)
1/4"	8	(11)	M4	(2)	3
5/16"	17	(23)	M5	(4.5)	6
3/8"	30	(40)	M6	(7.5)	10
7/16"	48	(66)	M8	(18)	25
1/2"	74	(100)	M10	(37)	50
9/16"	106	(144)			
5/8"	148	(200)			
3/4"	269	(364)			

# PARTS LIST

ITEM	PART NO.	DESCRIPTION	QTY	ITEM	PART NO.	DESCRIPTION	QTY
A1	95893	LH BUMPER MNT BRKT	1	B1	2595	1/2-13 X 4 HEX CAPSCREW	10
A2	95892	LH FRAME BRKT	1	B2	2596	1/2 LOCK WASHER	30
A3	95890	RH BUMPER MNT BRKT	1	B3	1323	1/2-13 HEX NUT	30
A4	95889	RH FRAME BRKT	1	B4	9213	1/2 FLAT WASHER	60
A5	95887	SKID PLATE	1	B5	22535	1/2-13X1-3/4 HEX CAPSCREW	16
A6	95894	BUMPER	1	B6	2583	7/16-14 HEX NUT	4
A7	94888	LIGHT PORT RH	1	B7	1824	7/16-14X1-1/4 HEX CAPSCREW	4
A8	94889	LIGHT PORT LH	1	B8	90327	5/16-18 X 1 BUTTONHEAD CAPSCREW	5
A9	95438	LIGHT PORT BRACKET LH	1	B9	2002	5/16-18 LOCK NUT	5
A10	95458	LIGHT PORT BRACKET RH	1	B10	2146	7/16 LOCK WASHER	4
				B11	91541	10-24X1.25 SOCKET HEAD CAPSCREW	20
				B12	100661	9/16 LOCKING PLUG	6
				B13	96546	SENSOR HOLE PLUG (shown on pg. 10)	6

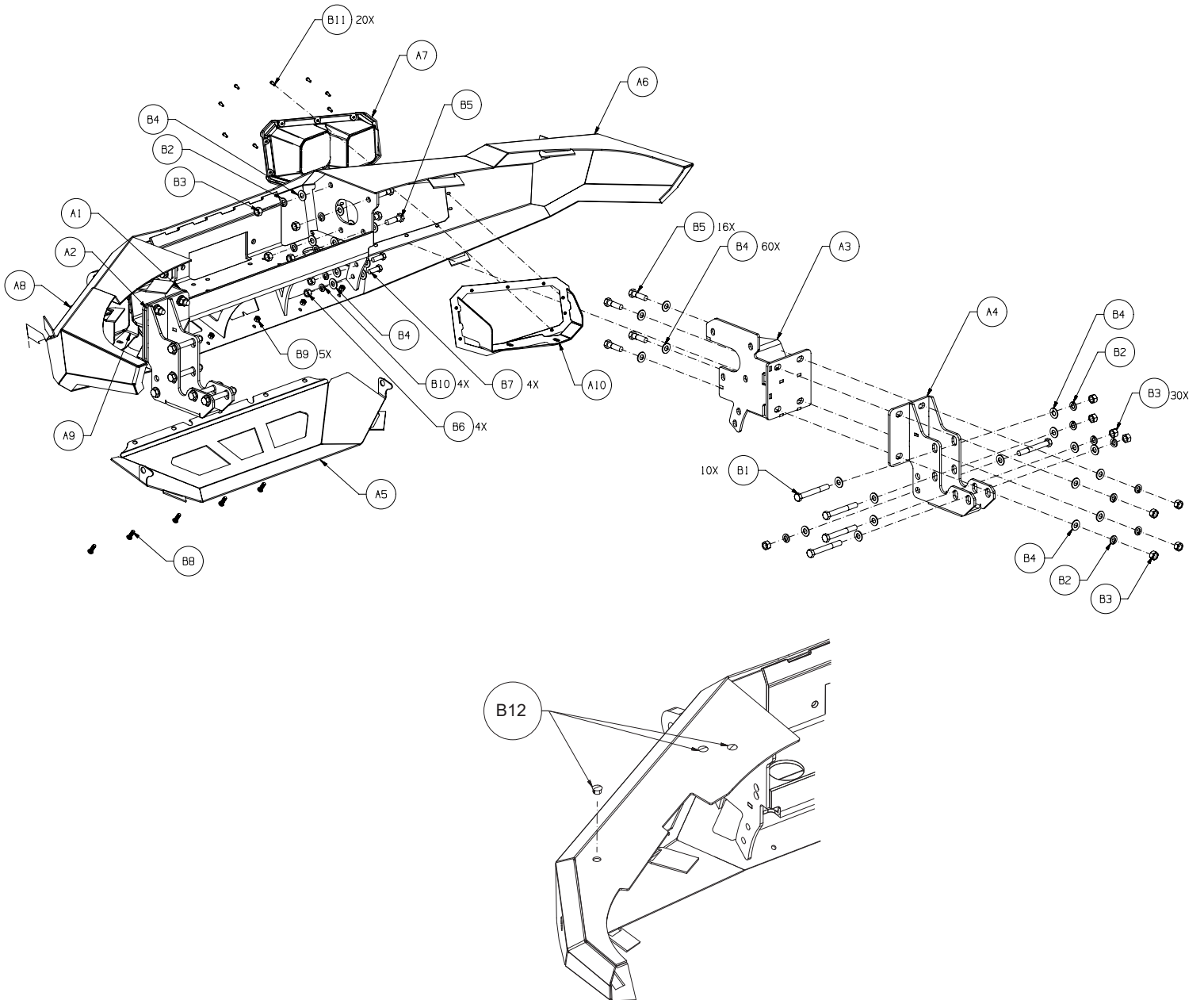

# INSTALLATION INSTRUCTIONS



Figure 1

1. Remove screw from the inner fender well (each side).



Figure 2

2. Remove plastic radiator fan cover by carefully removing the four christmas tree clips. *Keep all hardware and cover, you will be reinstalling later.*



Figure 3



## INSTALLATION INSTRUCTIONS

3. On right side of vehicle, near tow hook, find block heater plug. Unclip plug harness from bumper.

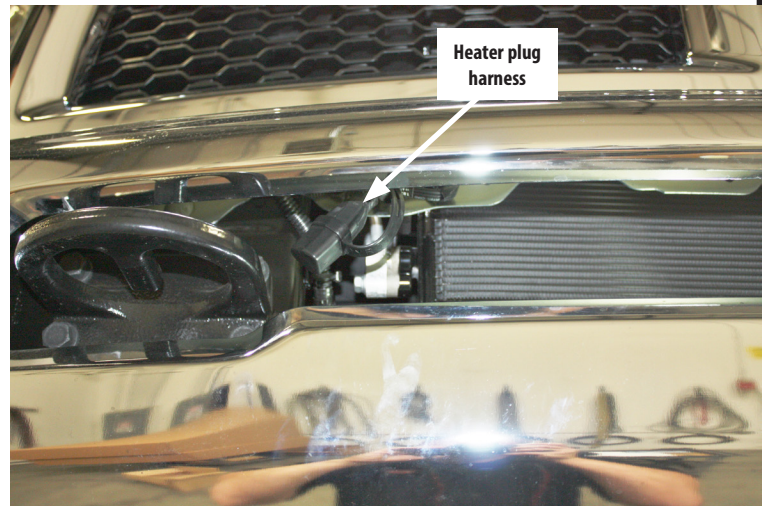

Figure 4

4. Remove the four flange head screws holding grille in place. Next, carefully pull grille away from the vehicle and unsnap clips (two on each side) to free grille completely.

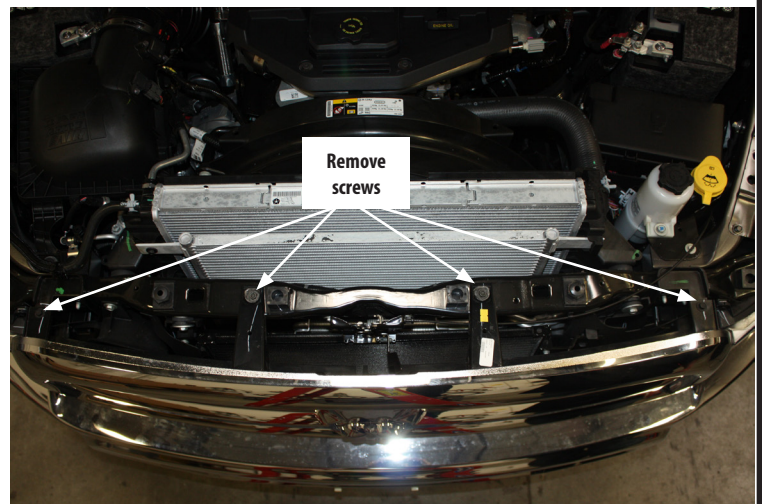

Figure 5

5. From underneath the vehicle, remove the three flanged nuts from the vehicle bumper mounting frame bracket (fourth nut will be removed from above vehicle in step 8).
6. Remove the two flanged nuts from the tie bolts.
7. Repeat all for other side.

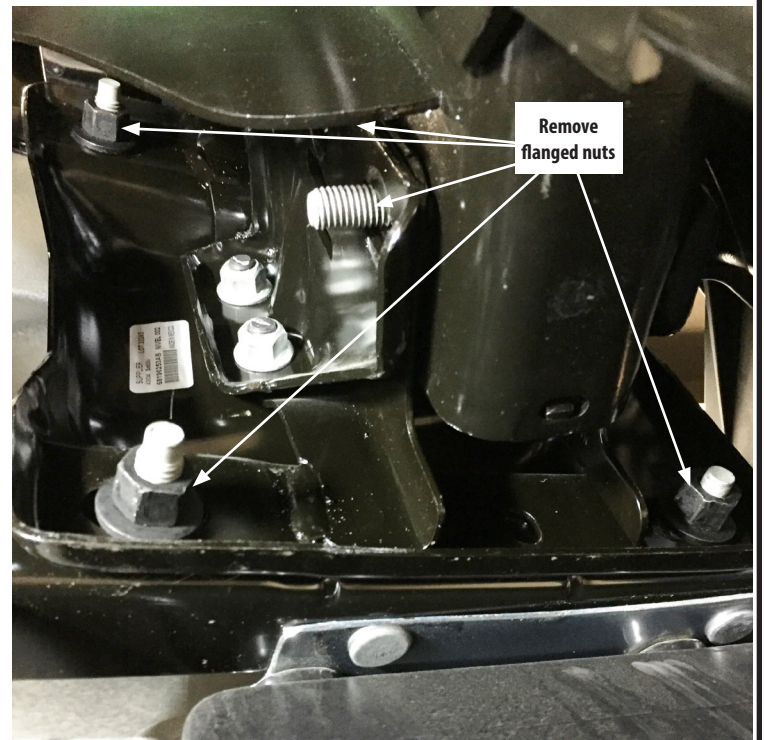

Figure 6

8. From above vehicle and with assistance, remove the fourth flanged nut from vehicle bumper mounting frame bracket.

**⚠ CAUTION**

- Always use assistance when moving or lifting heavy parts.

9. With assistance, remove bumper from vehicle.

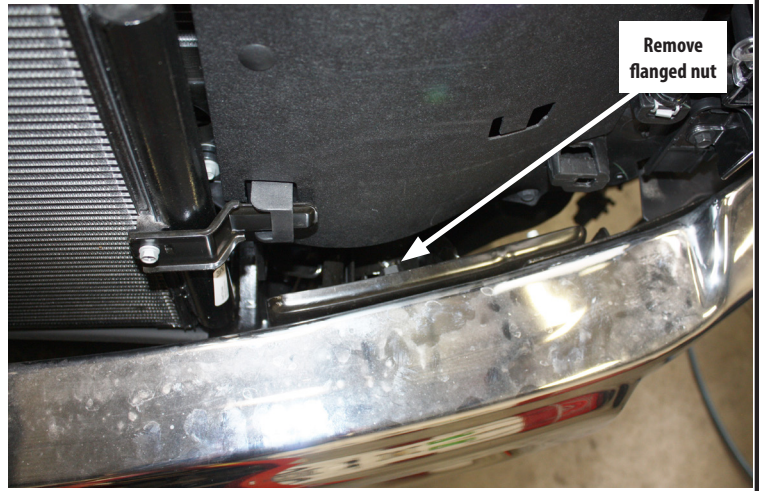

Figure 7

10. Remove intercooler shroud by removing the four screws and three christmas tree push pull clips.

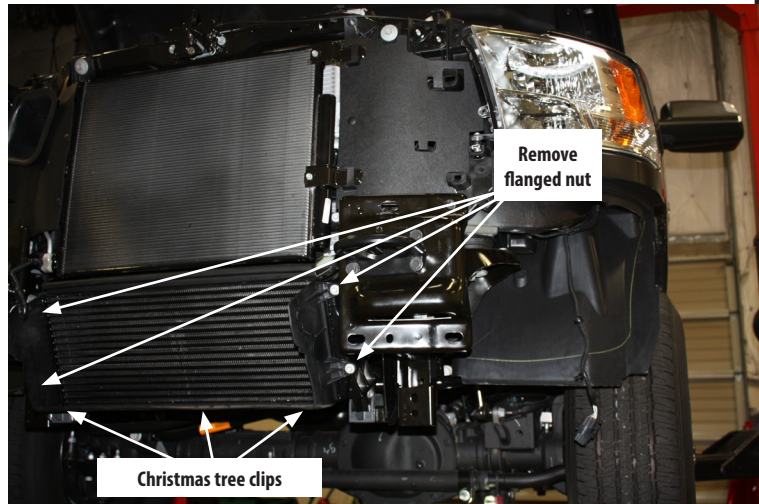

Figure 8

11. Remove collision brackets (both sides). You will not be reinstalling.

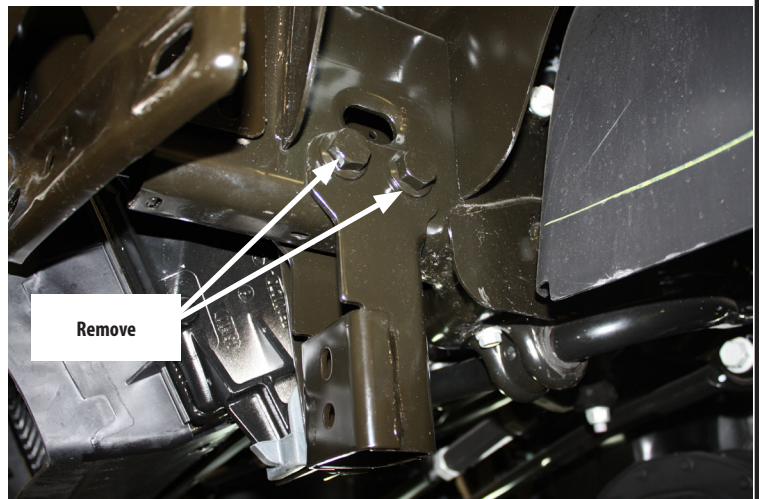

Figure 9



## INSTALLATION INSTRUCTIONS

**NOTE:** For these next few steps, we recommend working one side of the vehicle at a time for ease of installation.

12. Remove the hose clamp from intercooler tube (near base of intercooler).
13. Remove the two bolts to release the intercooler mounting bracket from frame of vehicle. Set aside, you will be reinstalling.

**NOTE:** Let intercooler hang down to remove tie bolt plate. Do not remove intercooler completely.

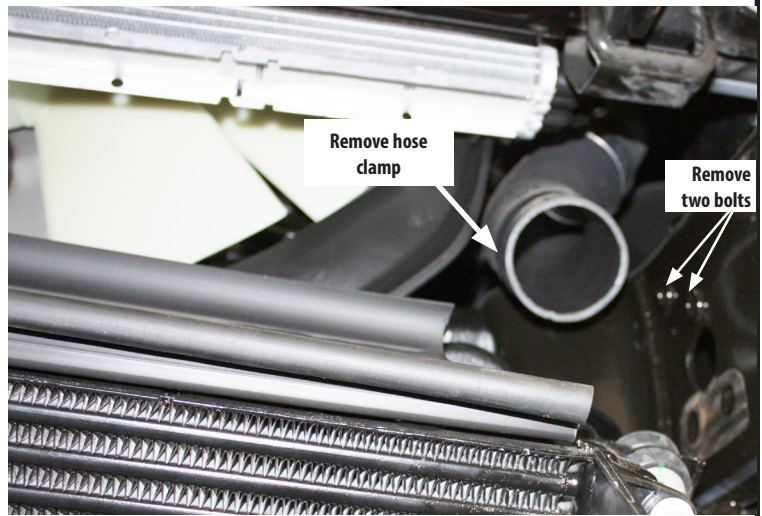

Figure 10

14. Remove tie bolt plate.

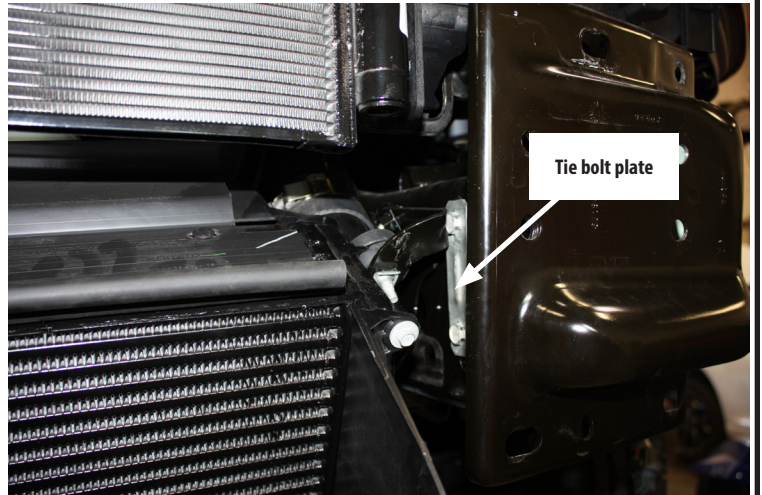

Figure 11

15. Remove the stock front bumper mounting frame bracket from frame.

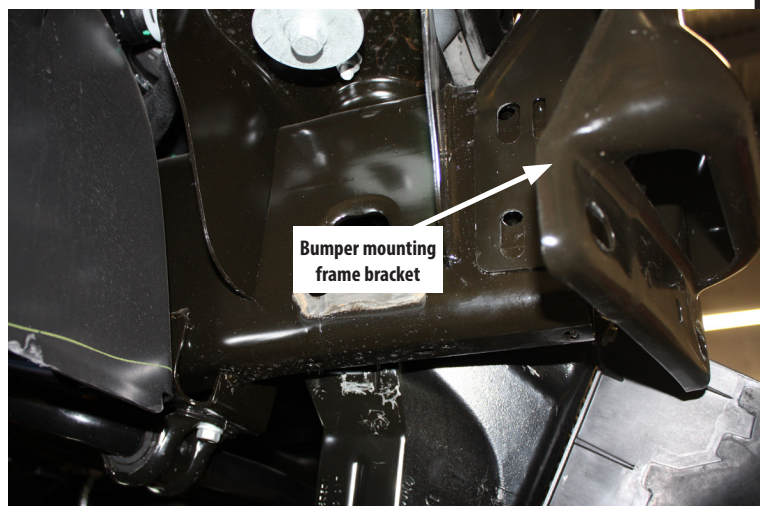

Figure 12

## INSTALLATION INSTRUCTIONS

16. Install frame bracket with hardware B1, B2, B3 and B4. Refer to exploded view for details. Hand tighten only at this time.
17. Reinstall the intercooler mounting bracket and hose and then move on to the other side.

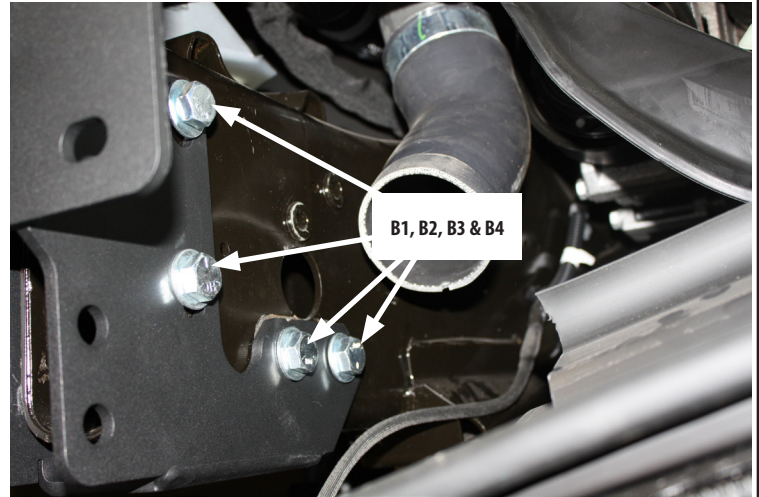

Figure 13

18. Repeats steps 12-17 for other side of vehicle.

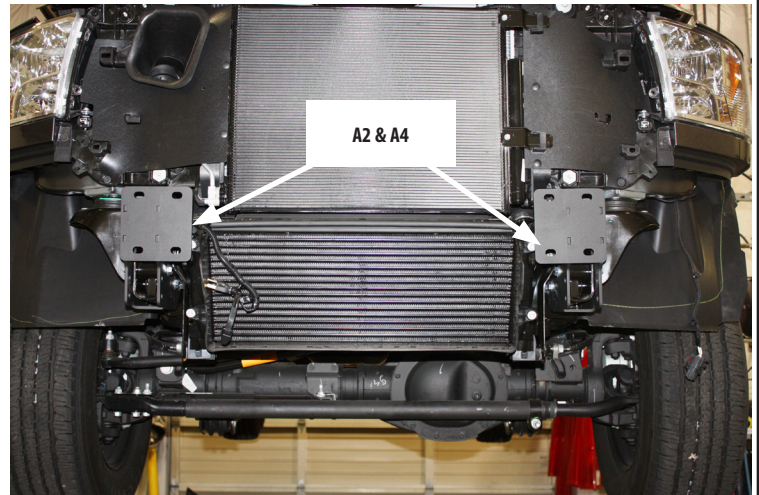

Figure 14

19. Install bumper mounting brackets (A1 & A3) with hardware B1, B2, B3, B4 and B5.

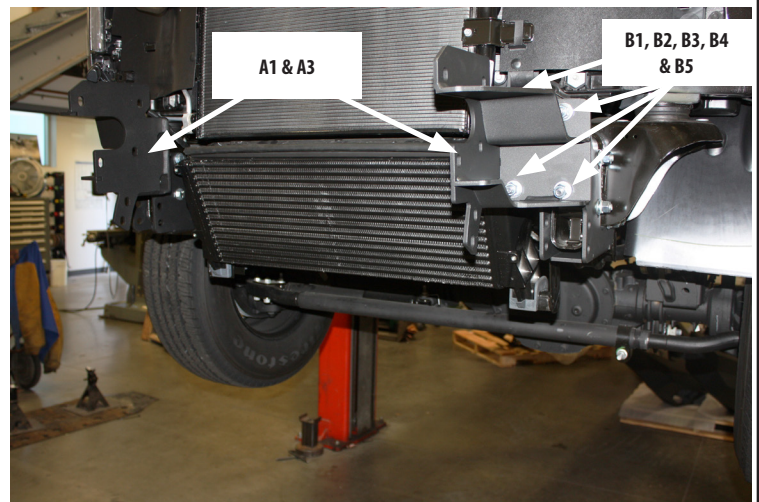

Figure 15



## ⚠ CAUTION

- **Always** use assistance when moving or lifting heavy parts.

20. With assistance, position bumper (A5) in place. Fasten using, B2, B3, B4, B5, B6, B7 and B10 hardware (each side).

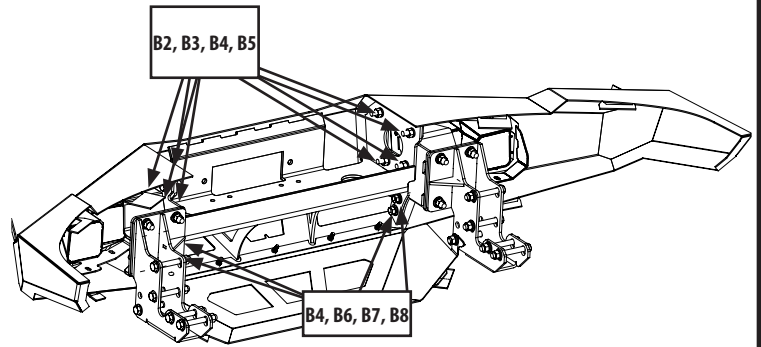

Figure 16

21. Once bumper is in position, tighten all hardware at this time.



Figure 17

22. With a zip tie, secure block heater plug up and out of the way.

23. Mark inner fender flap and carefully trim excess off.

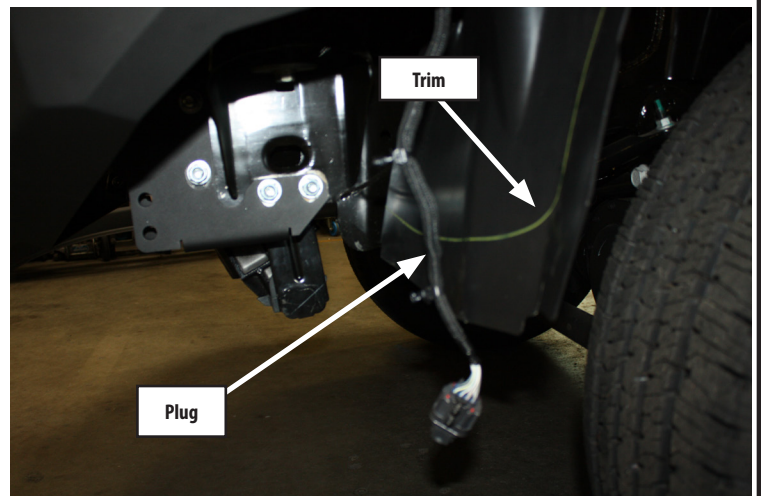
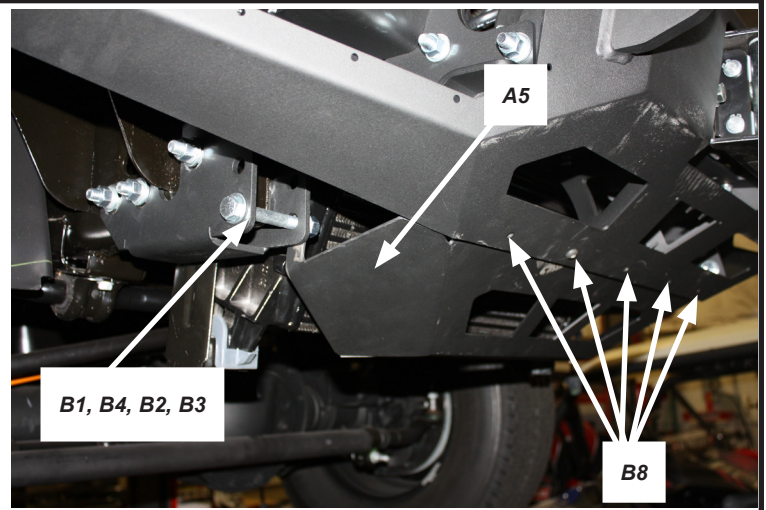

Figure 18

24. Install skid plate (A5) to bottom of bumper with (B8) hardware and (B1) bolt, two washer (B4), lock washer (B2) and hex nut (B3).



25. While holding light bracket (A9) in place (from under and behind bumper), line up light port (A8) through front bumper light port to bracket. Secure pieces together with ten stainless steel socket head screws (B11). Review exploded view on page 3.

26. Repeat for other side.

**NOTE:** Light bezels are equipped with removable panels for lights. Lights show installed sold separately.

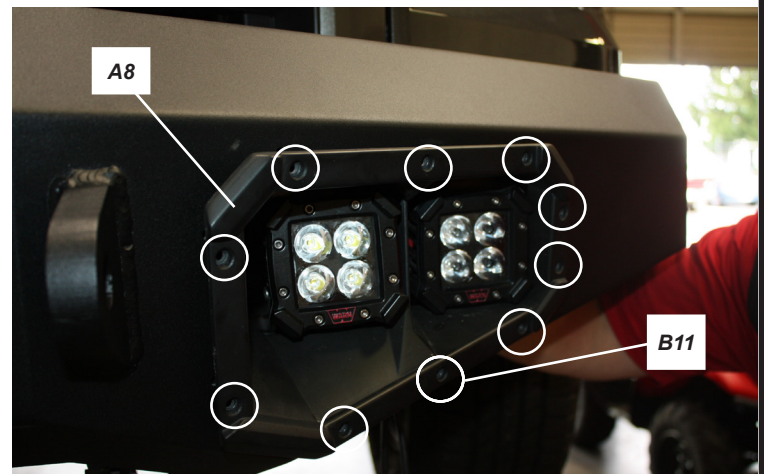

Figure 20

27. If equipped, remove bumper support backing plate off stock bumper to expose park sensor harness, sensors and sensor carriage.

28. Remove park sensor harness.

29. Remove sensors from sensor carriage.

30. Remove the carriage from stock bumper.

31. Install sensor carriage into new Warn bumper in the same orientation as it was removed from stock bumper.

**NOTE:** If vehicle is not equipped with sensors, use provided sensor hole plug to install in new Warn bumper.

32. Install sensor into carriage and park sensor harness into new Warn bumper.

**NOTE:** You may have to lengthen your harness in some applications.

33. If not installing optional Ascent bar accessories, plug unused holes with provided hole plugs (B12). Refer to exploded view on page 3.

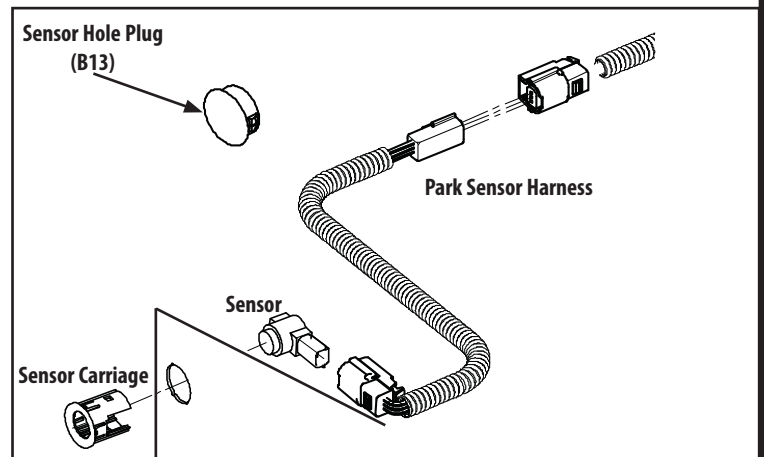

Figure 21

34. Your installation is now complete.



## MAINTENANCE / CARE

1. Inspect all parts on the winch, winch mount, and related hardware prior to each use. Replace all hardware that appears rusted or deformed.
2. Inspect all nuts and bolts on the winch, winch mount,, and related hardware prior to each use. Tighten all nuts that appear to be loose. Stripped, fractured, or bent bolts or nuts need to be replaced.
3. Check all cables prior to use. Replace cables that look worn or frayed.
4. Check all moving or rotating parts. Remove debris that may inhibit the part from moving freely.

**CARELESS INSTALLATION AND OPERATION CAN RESULT IN SERIOUS INJURY OR EQUIPMENT DAMAGE. READ AND UNDERSTAND ALL SAFETY PRECAUTIONS AND OPERATING INSTRUCTIONS BEFORE INSTALLING AND OPERATING THIS PRODUCT.**

