



Alumilite Front Bumper

part# AL-FBM71TYN-RT

DIRECTIONS FOR INSTALLATION & USE

2014 - 2021 TOYOTA 4RUNNER

For technical support, call 1-800-626-8746

or

visit icionline.com to download color instructions



ATTN: STATE OF CALIFORNIA CONSUMERS

WARNING: CANCER AND REPRODUCTIVE HARM

-WWW.P65WARNINGS.CA.GOV



WARNING: FAILURE TO COMPLY WITH INSTALLATION, SAFETY, AND PRODUCT USE INSTRUCTIONS MAY RESULT IN SERIOUS BODILY INJURY OR DEATH.

IMPORTANT NOTES

The contents of this installation and operation manual should be read and comprehended before initializing the installment of the above listed product. This will help minimize risk to injury through the installation process and through the operation of the product.











TABLE OF CONTENTS

1. SAFETY, WARNINGS, AND OPERATION	02
2. PARTS AND TOOLS REQUIRED	03
3. REFERENCE DIAGRAMS.	04
4. DISMOUNTING THE OEM BUMPER	05-10
5. ICI BUMPER INSTALLATION.	10-14
6. SOCIAL MEDIA REFERENCE	14

SAFETY, WARNINGS, AND OPERATION

- Please ensure that the installer and end-user of this product have familiarized themselves with the contents in this manual. This manual provides important information about the possible safety and operation risks that are involved with the usage of this product.
- Our number one concern is the safety of our customers. This product is intended to be installed by a professional to minimize risk of an improper installation. Improper installations can lead to product damage, vehicle damage, and bodily injury. We ask that you reach out for professional assistance if this installation is beyond your capabilities.
- Please ensure to safeguard this installation and operation manual to reference in the future or to pass on to a future owner of the product.
- The installation of the TOYOTA 4RUNNER ALUMILITE BUMPER requires the dismantling and cutting of the OEM bumper. Please follow all instructions and take all safety precautions necessary throughout the entirety of the installation process.

2. PARTS AND TOOLS REQUIRED

SYMBOL	DESCRIPTION	TOOL	DESCRIPTION
	HAZARDOUS WARNING		RATCHET/SOCKET WRENCH
	WARNING: SHARP ELEMENTS		SOCKETS (MM): 10, 14
	WARNING: CRUSHING OF HANDS		DREMEL
	WARNING: HOT SURFACE		AUTO TRIM REMOVAL TOOL
	MANDATORY: WEAR EYE PROTECTION		EYE PROTECTION

PARTS AND TOOLS REQUIRED

Hardware Kit includes:

- (1). Qty x 14 = M8-1.25 x 30mm Flat Head Socket Screws
- (2). Qty x 14 = M8 x 30mm Finish Washers
- (3). Qty x 26 = M8 Flat Washers
- (4). Qty x 12 = M8-1.25 Nylock Nuts
- (5). Qty x 6 = M8-1.25 x 30mm Hex Head Bolts
- (6). Qty x 2 = M12-1.25 x 30mm Hex Head Bolts
- (7). Qty x 2 = M12 Flat Washers
- (8). Qty x 4 = 1/2" RT Hole Plugs

Components List:

- (a). Steel Winch Plate Assembly (100513)
- (b). Aluminum Winch Plate Bumper Cover (100515)
- (c). Internal Light Mount (100516)
- (d). Lower Bumper Supports (100517) - Qty x 2
1 Driver / 1 Passenger
- (e). Trim-Loc Rubber Edging - Qty x 2
- (f). RT Hoop Bar (Bolt-on)

REFERENCE DIAGRAMS

Front view of Bumper and Winch Carrier set-up:

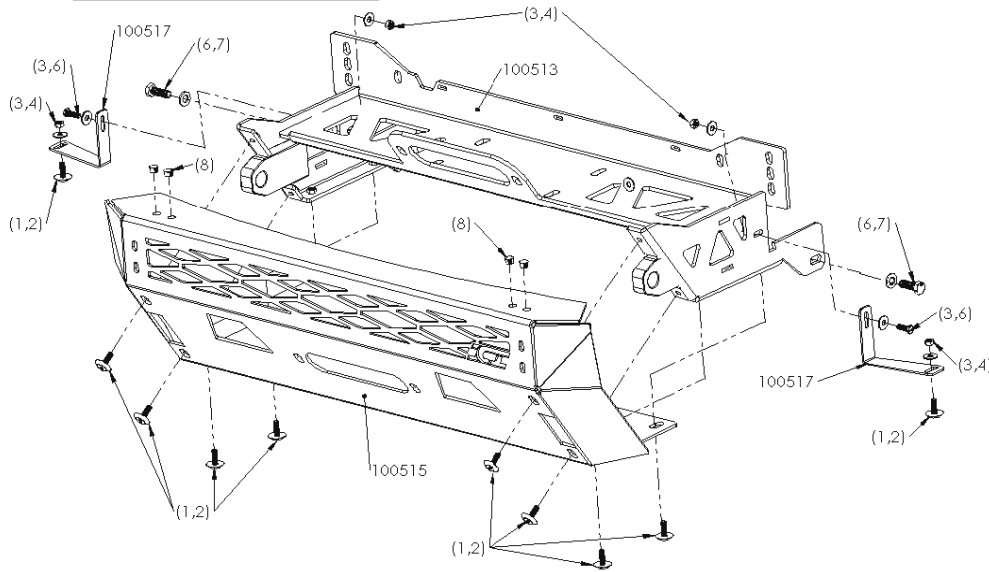

Back view of bumper, RT Hoop, and Internal Light Bracket set-up:

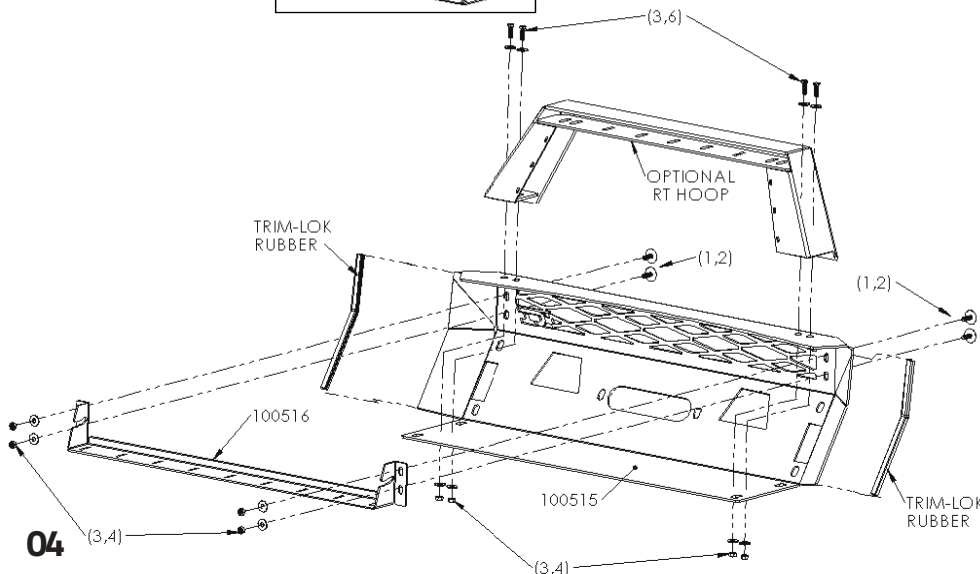
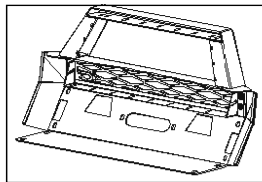

DISMOUNTING THE OEM BUMPER

STEP 1

Open the hood of your 4Runner and remove the top plastic radiator cover by removing the 10 plastic retainer clips. Simply push in the center of the clips (like a button) to disengage them.

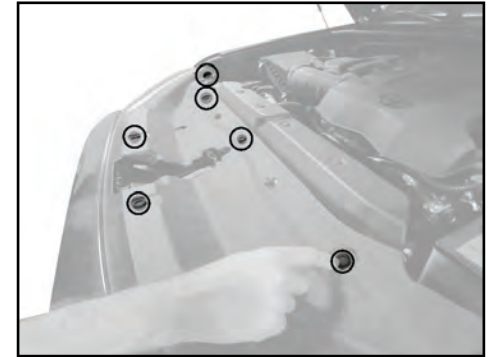

Figure 1.

STEP 2 (SAVE COMPONENTS)

With a 10mm socket, remove the 3 bolts attaching the bumper cover to the center of the radiator support. The top bolt is shown in *Figure 2*. Follow the bumper cover down to find the 2 bolts located directly beneath it.



Figure 2.

STEP 3 (SAVE COMPONENTS)

With a trim removal tool, remove the 6 plastic retainer clips holding the bumper cover to the radiator support. If equipped, unplug the TSS sensor harness as well.

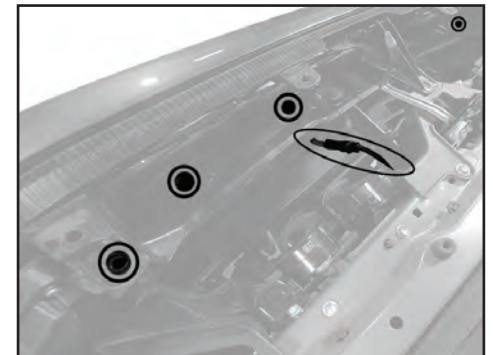

Figure 3.

DISMOUNTING THE OEM BUMPER

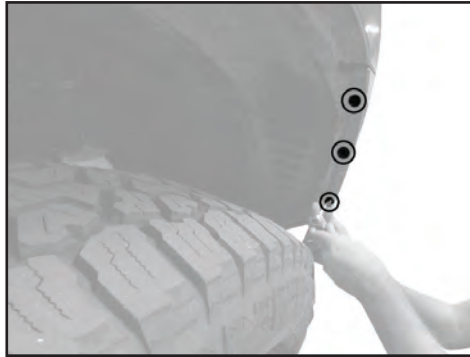

Figure 4.

STEP 4 (SAVE COMPONENTS)

Using a 10mm socket, remove the 3 screws from the front of each wheel well holding the bumper cover to the inner fender liner. Note the bolts and which location they were removed from so they can be reinstalled later.

STEP 5

Using a 10mm socket, remove the 2-3 screws from each side underneath the bumper cover holding it to the inner fender liner.



Figure 5.

STEP 6

Using a 10mm socket remove the 7 bolts underneath the center of the bumper cover holding on the plastic skid plate. Using a small flat head screw driver remove the plastic retainer pin holding the plastic skid plate to the frame. Remove the plastic skid plate. *Figure 6* is with the plate removed.

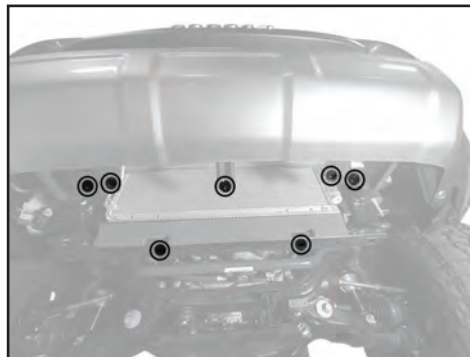

Figure 6.

DISMOUNTING THE OEM BUMPER

STEP 7 (SAVE COMPONENTS)

Disconnect the fog light harness, there is a plug located under the driver side headlight that can be accessed underneath the bumper. This plug has a lever to release it from the harness, disconnect the harness by pulling the lever until it releases.



Figure 7.

STEP 8 (SAVE COMPONENTS)

To avoid damage, we recommend having someone help to remove the bumper cover. From the wheel well, pull the bumper away from the fender. As it loosens, slip your fingers between the bumper cover and fender and work towards the front of the vehicle. Do this carefully from both sides.

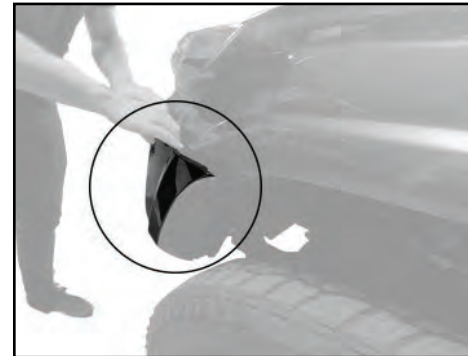

Figure 8.

STEP 9

Use a 14mm socket or wrench to remove the crash bar from the frame. There are 4 bolts per side, 3 on the outside and 1 on the inside of each frame mount. The crash bar is also attached by hooks. With the bolts removed, lift up on the crash bar to unhook it from the frame. The crash bar will not be used for the ICI bumper.

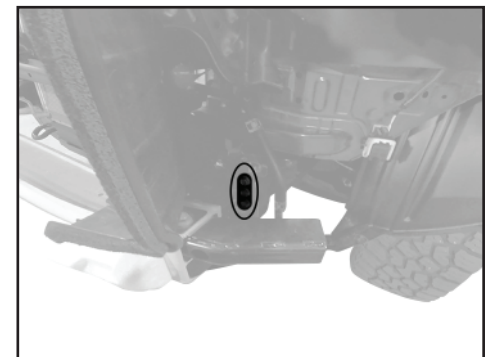

Figure 9.

DISMOUNTING THE OEM BUMPER

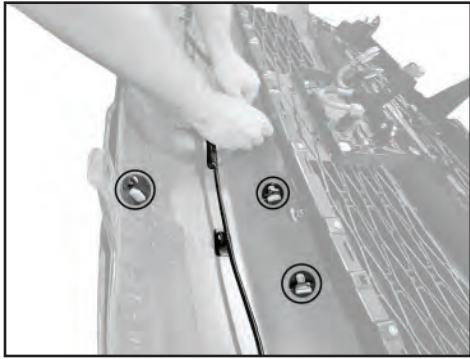

Figure 10.

STEP 10

Remove the front plastic trim cover and fog light harness from the bumper cover. Gently pull on the clips until they come off the bumper. Using a flat head screw driver, release the white plastic retainer pins holding the trim piece to the front of the bumper cover.

STEP 11

Create a cut line along the top of the bumper cover by masking off the top edge just below the lower grille, tape off about 2" below the lower grille opening.



Figure 11.



Figure 12.

STEP 12 (SAVE COMPONENTS)

Using the front plastic trim cover removed in STEP 10 as a guide, trace a line with a sharpie over the tape to act as a "cutting" line. Once the line is drawn, remove the plastic trim cover and set it aside.

DISMOUNTING THE OEM BUMPER

STEP 13

Remove the lower grille insert. Using a Phillips head screw driver, remove the 6 screws holding the metal grille retainer to the bumper cover. Using a flat head screw driver, unclip the lower grille from the bumper cover and remove. Set these parts aside for re-installation after cutting.

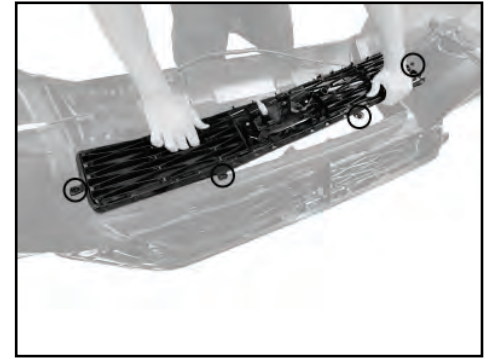

Figure 13.

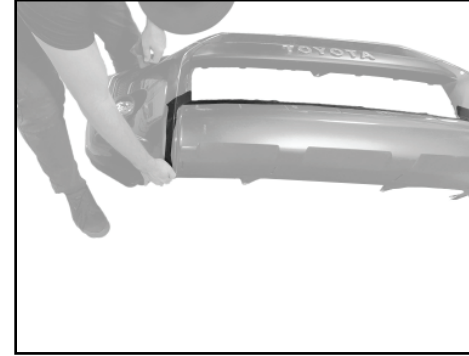

Figure 14.

STEP 14

Finish taping off the edge of the bumper cut area. The cut will follow the top line and down the valley of the bumper cover. Tape off outside of this area to protect it from contact with the cutting tool.

STEP 15

Using a cut off wheel, air saw or similar type cutting tool, begin cutting along the top line and down the valleys of the bumper cover. The ICI bumper will cover these cut areas, so the cuts do not need to be perfect.

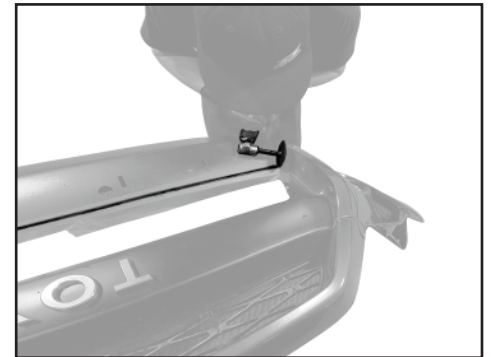

Figure 15.

DISMOUNTING THE OEM BUMPER

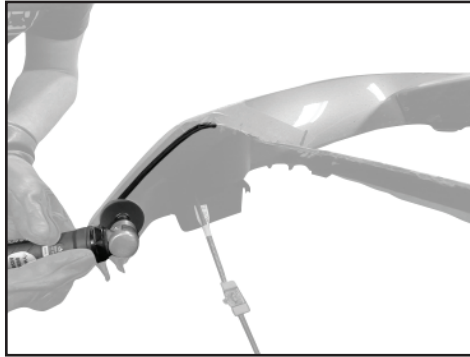

Figure 16.

STEP 16

Clean up the edges with a light sanding and remove all the masking tape.

ICI BUMPER INSTALLATION

STEP 17

With the edges sanded, the bumper cover is ready to be reassembled and remounted to your truck. You will need to reinstall the components of the following steps in this sequence: STEP 12, STEP 8, STEP 7, STEP 4, STEP 2, and STEP 3.



Figure 17.



Figure 18.

STEP 18 (WINCH)

If you have a winch, now is the time to mount it to the carrier. Be sure to use the hardware provided with your winch. This carrier is designed to fit most winch brands, it may be necessary to relocate the solenoid control box depending on the winch brand and style.

ICI BUMPER INSTALLATION

STEP 19

Install the ICI winch carrier to the frame of the vehicle. With help, carefully hold the winch carrier up to the front frame and use the eight 14mm socket head bolts removed in STEP 9 to attach the winch carrier to the frame. Do not fully tighten these bolts yet.



Figure 19.

STEP 20

Use the provided M12 bolts and flat washers on the lateral holes of the winch carrier to fix it to the frame. With these bolts in place and tightened, proceed to tightening the 8 bolts in STEP 19.



Figure 20.

STEP 21 (WINCH)

Be sure to take caution with the AC and cooler lines. If a line is making contact with the winch, you will need to adjust it/them to avoid damaging it. These lines can be gently bent by hand, but it may be necessary to unbolt the line. NOTE: Be careful and only proceed at your own discretion.

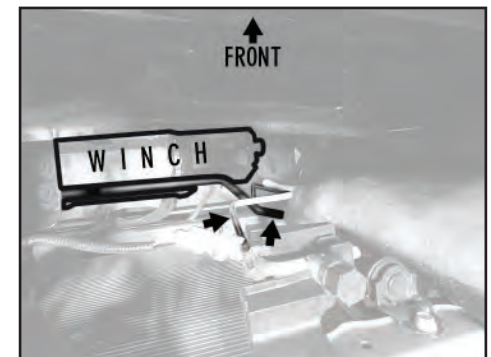

Figure 21.

ICI BUMPER INSTALLATION

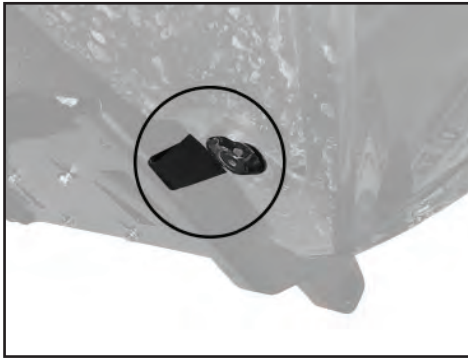

Figure 22.

STEP 22

Install the side support brackets to the winch carrier with the provided M8 hardware.

NOTE: Do not fully tighten and do not attach to the bumper cover as illustrated yet. This is done to illustrate where the support attaches.

STEP 23

The small slots along the back edge of the winch carrier are for wire management, the winch wires and fog light harness can be zip tied to these slots to keep them out of the way and secure.

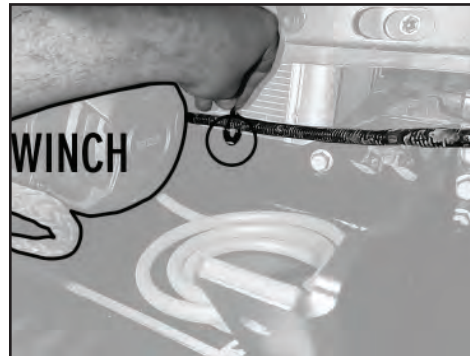

Figure 23.

STEP 24 (LIGHTING)

Install the lighting of your choosing to the light mount bracket. Then mount the bracket to the cover plate and adjust it until your lighting is centered on the front opening.

NOTE: The light bracket accommodates up to a 30" LED light bar.



Figure 24.

ICI BUMPER INSTALLATION

STEP 25

Attach the provided rubber trim to the length of the side edges of the cover plate. It may be necessary to use a small mallet to ensure that the trim is properly attached.

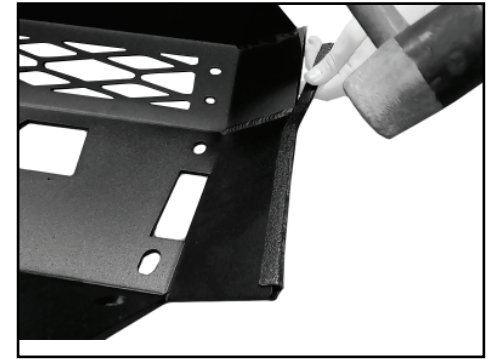

Figure 25.

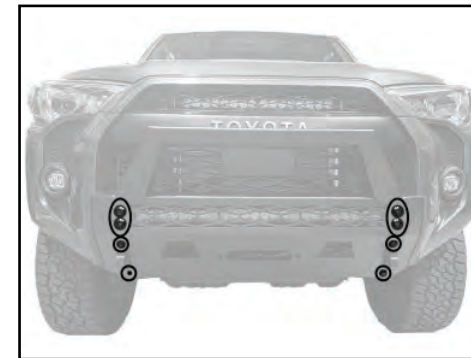

Figure 26.

STEP 26

Use 8 of the provided M8 bolts and finish washers to attach the cover plate to the winch carrier. Center the plate so it is square on the vehicle and tighten the mounting bolts. Also install the fairlead to the front of the winch cover plate - longer bolts may be necessary for this.

STEP 27

Attach the OE bumper cover to the side support brackets using the provided M8 bolt and finish washer. Adjust the bumper cover so it minimizes the gap between the winch cover plate and the OE bumper cover, once satisfied with the fitment, fully tighten all bolts. Refer to STEP 22.



Figure 27.

ICI BUMPER INSTALLATION

STEP 28 (Finish)

Check all hardware and make sure they are fully tightened.



Figure 28.

TAG ICI ON SOCIAL MEDIA

www.facebook.com/InnovativeCreationsInd



www.instagram.com/ici_usa



Hashtags:

#ICIUSA
#ICIAlumilite
#AlumiliteSteps
#AlumiliteBumpers