



INSTALLATION GUIDE

21-UP/FORD F-150 RAPTOR RACE SERIES DOVETAIL REAR BUMPER R210245090103



TOOLS REQUIRED

- (Torx) T40
- (Allen) 5/32
- (Wrench) 10mm, 7/16, 9/16
- (Socket) 10mm, 7/16, 9/16
- Ratchet
- Flat Head/Fastener Remover
- Grinder
- Cutoff Wheel
- Black Spray Paint
- Zip Ties



TIME REQUIRED

- 3.5 hours for OEM Removal/Cut/Bumper Install
- 1 Additional Hour to Wire Lights

****Labor Rates are based on a vehicle with no pre-existing damage. Wiring labor is based on a standard wiring procedure with light switches installed in an easily accessible location. Custom light triggering or switch mounting location will result in a greater labor charge.****



SKILL LEVEL

-Medium/Skilled

****This installation requires 2 people for best results****

⚠️ WARNINGS/CAUTIONS BEFORE STARTING INSTALLATION ⚠️

-BEFORE YOU INSTALL THIS KIT-

Read and understand all instructions, warnings, cautions, & notes contained in this installation instruction guide. Consult your vehicle owner's manual for proper disconnection of electrical and lifting of vehicle if required for installation of this product.

This install may require some technical skills and knowledge of basic mechanical work. If you do not feel that you are capable of performing this install please take this product to a trained professional.

After reading this guide please contact us with any questions or concerns before installing product.

Customer Service (480) 671-0820

Addictive desert designs is not responsible for any bodily injury or harm to you or your vehicle as a result of an improper install.

Proper installation of this kit required knowledge of the factory recommended procedures for removal and installation of original equipment components.

We recommend that the factory shop manual and any special tools needed to service your vehicle be on hand during the installation. Installation of this kit without proper knowledge of the factory recommended procedures may affect the performance of these

components and the safety of the vehicle. Inspect all contents of this package to make sure product is not damaged and all installation hardware has been included. If parts are missing from kit, please be prepared to provide the following information:

1. Name of purchase location
2. Bar Code on side of box
3. Date above bar code
4. Date inside box cover

ALWAYS WEAR EYE PROTECTION WHEN OPERATING POWER TOOLS



INSTALLATION GUIDE

HARDWARE/PARTS

A.

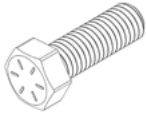

3/8-16 X 1" HEX HEAD BOLT GRADE 8

QTY: 4

A1.



3/8-16 NYLON LOCK NUT BLACK

QTY: 4

A2.



3/8 FLAT WASHER BLACK

QTY: 8

B.



1/4-20 X 3/4" BUTTON HEAD BOLT BLACK

QTY: 4

B1.



1/4-20" NYLON LOCK NUT BLACK

QTY: 4

B2.



1/4" FLAT WASHER BLACK

QTY: 4

C.



NYLON PLASTIC SNAP IN NUT

QTY: 2

C1.



1/4 X 3/4" TYPE B HEX HEAD BLUNT SCREW

QTY: 2

SENSOR GROMMETS SUPPLIED FOR NON SENSOR TRIMS



3/4" RUBBER SENSOR GROMMET

QTY: 4



3/4" PLASTIC SENSOR GROMMET PLUG

QTY: 4



INSTALLATION GUIDE

RACE SERIES DOVETAIL REAR BUMPER 21-UP/FORD F-150 RAPTOR

REMOVAL

□ STEP 1

Unplug the main wire harness located on the driver side by pulling the gray tab back as shown below. Remove the ground using a (10mm socket) located on the passenger side on the frame rail.

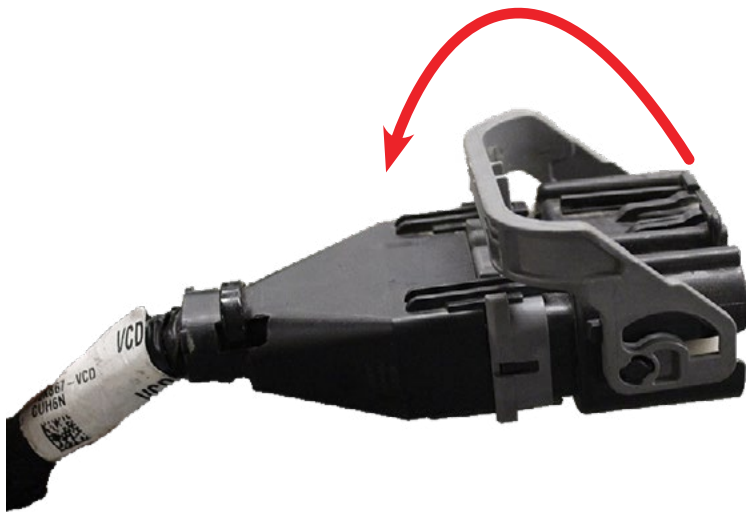



INSTALLATION GUIDE

RACE SERIES DOVETAIL REAR BUMPER 21-UP/FORD F-150 RAPTOR

REMOVAL

□ STEP 2

Unplug/remove the trailer harness connection from behind the bumper.



□ STEP 3

Remove the license plate light from the bumper.

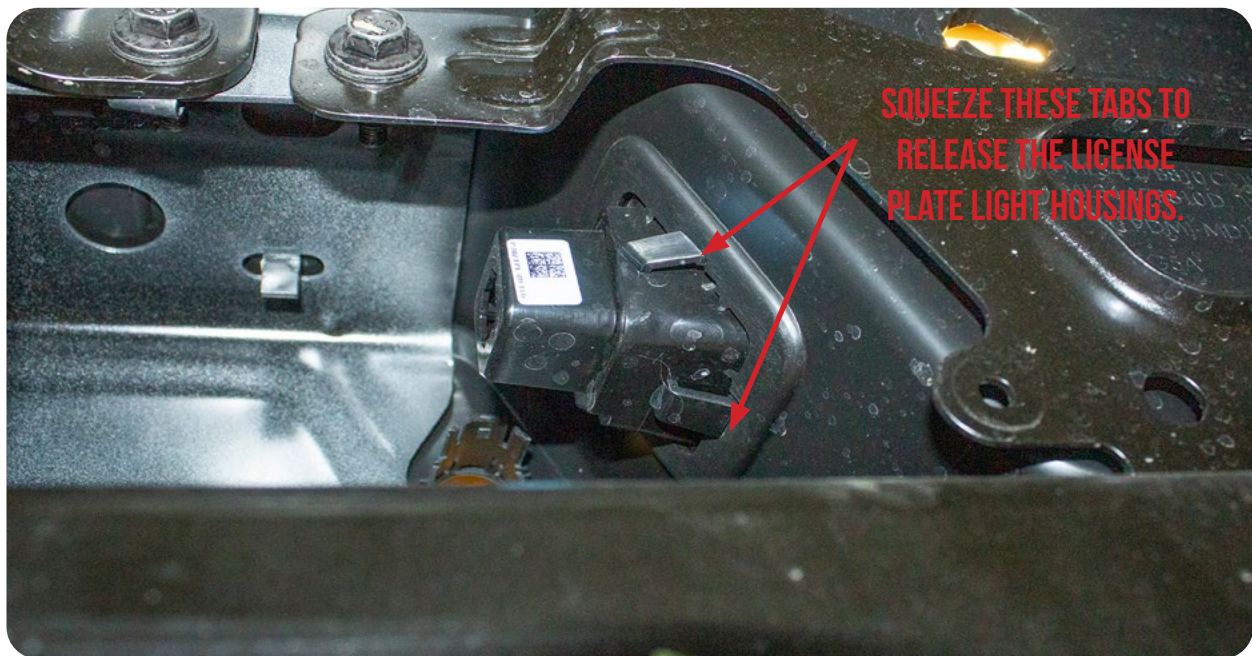

RACE SERIES DOVETAIL REAR BUMPER 21-UP/FORD F-150 RAPTOR

REMOVAL

□ STEP 4

Remove the parking sensors and bezels from the stock bumper, You can now remove the wire harness and set aside for install. ****Remember the location and orientation of the sensor bezels after removal for this will be important later on in the install****

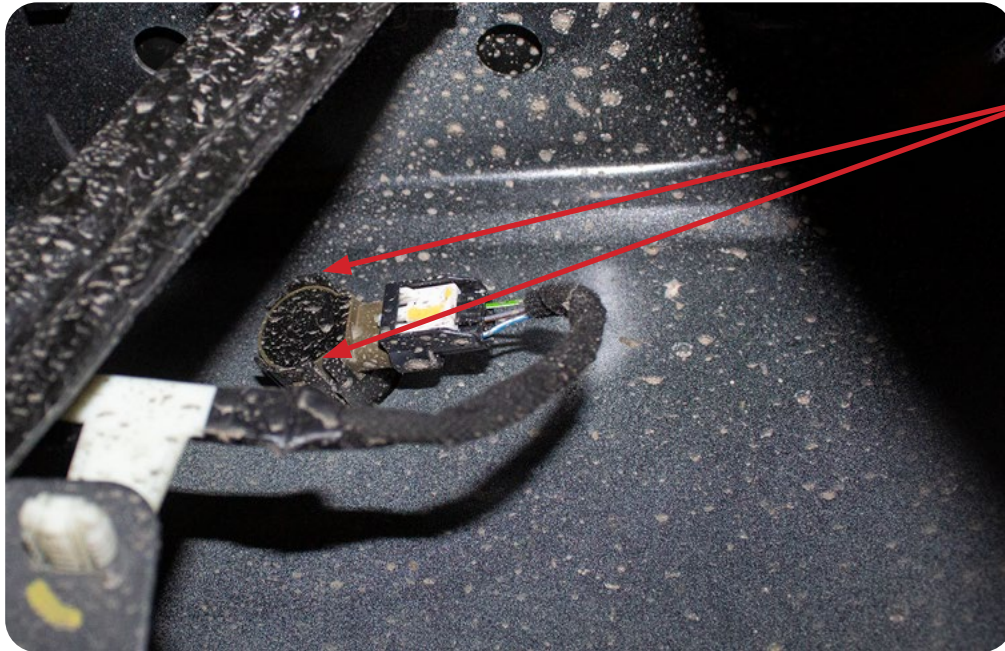

**SPREAD THESE TWO TABS
TO RELEASE THE PARKING
SENSOR.**

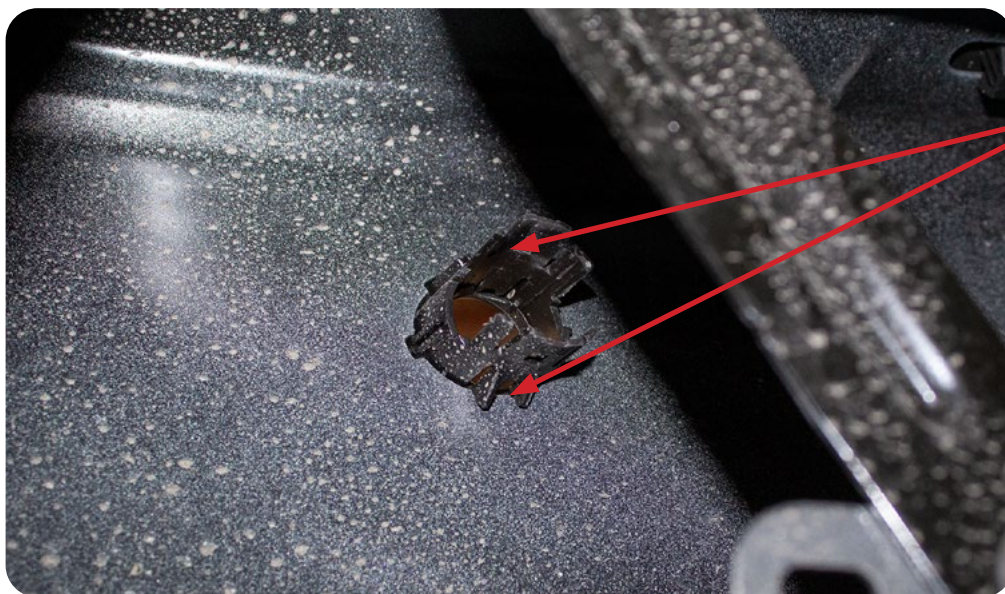

**SQUEEZE THESE TWO TABS
TO RELEASE THE PARKING
SENSOR MOUNTING RINGS.**



INSTALLATION GUIDE

RACE SERIES DOVETAIL REAR BUMPER 21-UP/FORD F-150 RAPTOR

REMOVAL

STEP 5

Pull firmly to removed the top plastic cover off the bumper. There are no tools required for this step, it simply pulls off by hand.





INSTALLATION GUIDE

RACE SERIES DOVETAIL REAR BUMPER 21-UP/FORD F-150 RAPTOR

REMOVAL

□ STEP 6

Using a (T40 torx), remove the mounting bolts that hold the bumper side covers to the vehicle.



RACE SERIES DOVETAIL REAR BUMPER 21-UP/FORD F-150 RAPTOR

REMOVAL

□ STEP 7

Remove the license plate bracket by using a (grinder) to grinding through the five visible welds that connect that bracket to the hitch. ****Once the bracket has been removed, paint over the raw metal to prevent rust****

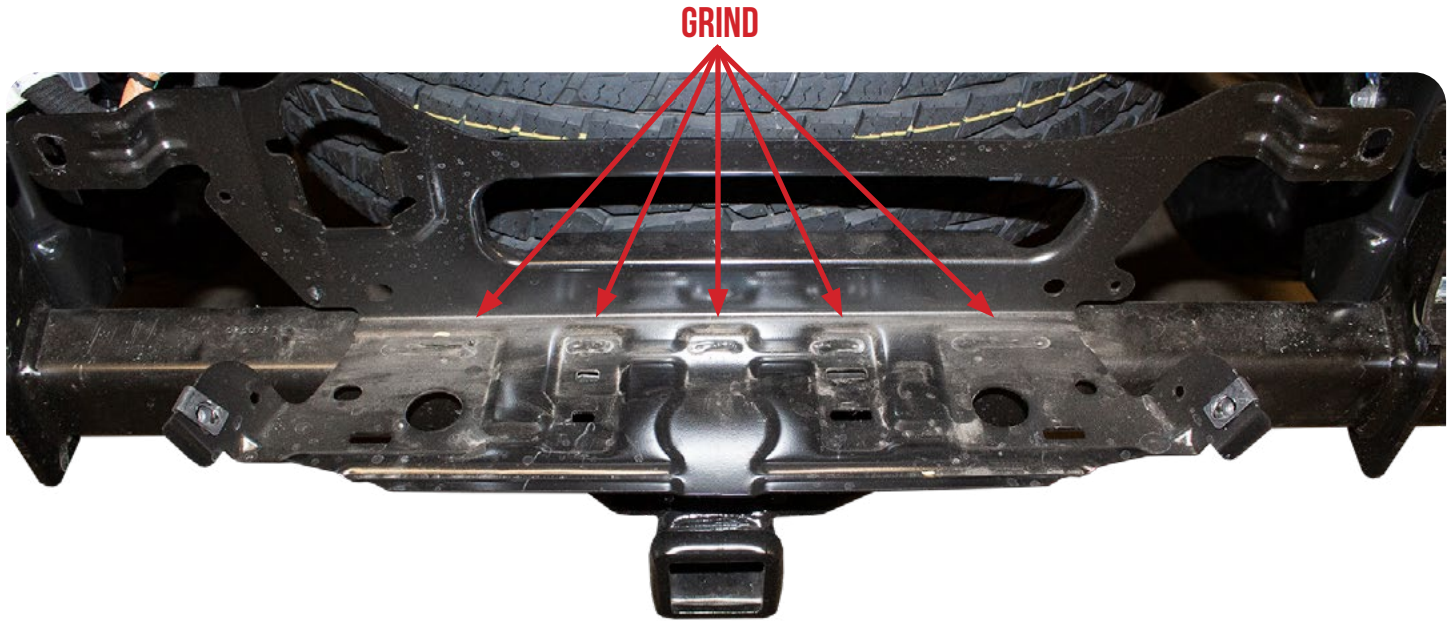



INSTALLATION GUIDE

RACE SERIES DOVETAIL REAR BUMPER 21-UP/FORD F-150 RAPTOR

INSTALL

STEP 8

Install the license plate lights as shown below.





INSTALLATION GUIDE

RACE SERIES DOVETAIL REAR BUMPER 21-UP/FORD F-150 RAPTOR

INSTALL

□ STEP 9

Install the trailer plug and pry out the tabs to securely seat plug using a (flathead screwdriver).





INSTALLATION GUIDE

RACE SERIES DOVETAIL REAR BUMPER 21-UP/FORD F-150 RAPTOR

INSTALL

□ STEP 10

Install the sensor bezels and sensors in the correct orientation from OEM. If your sensor bezels do not click into place, you may have to trim the mounting tabs to accommodate for the thickness of the material on your new bumper.



BEFORE



AFTER



TRIM HERE





INSTALLATION GUIDE

RACE SERIES DOVETAIL REAR BUMPER 21-UP/FORD F-150 RAPTOR

INSTALL

□ STEP 11

Now would be a good time to install the provided brackets for the cube lights with **(B, B1, B2)** 1/4" hardware using a (5/32 allen) and a (7/16 wrench).

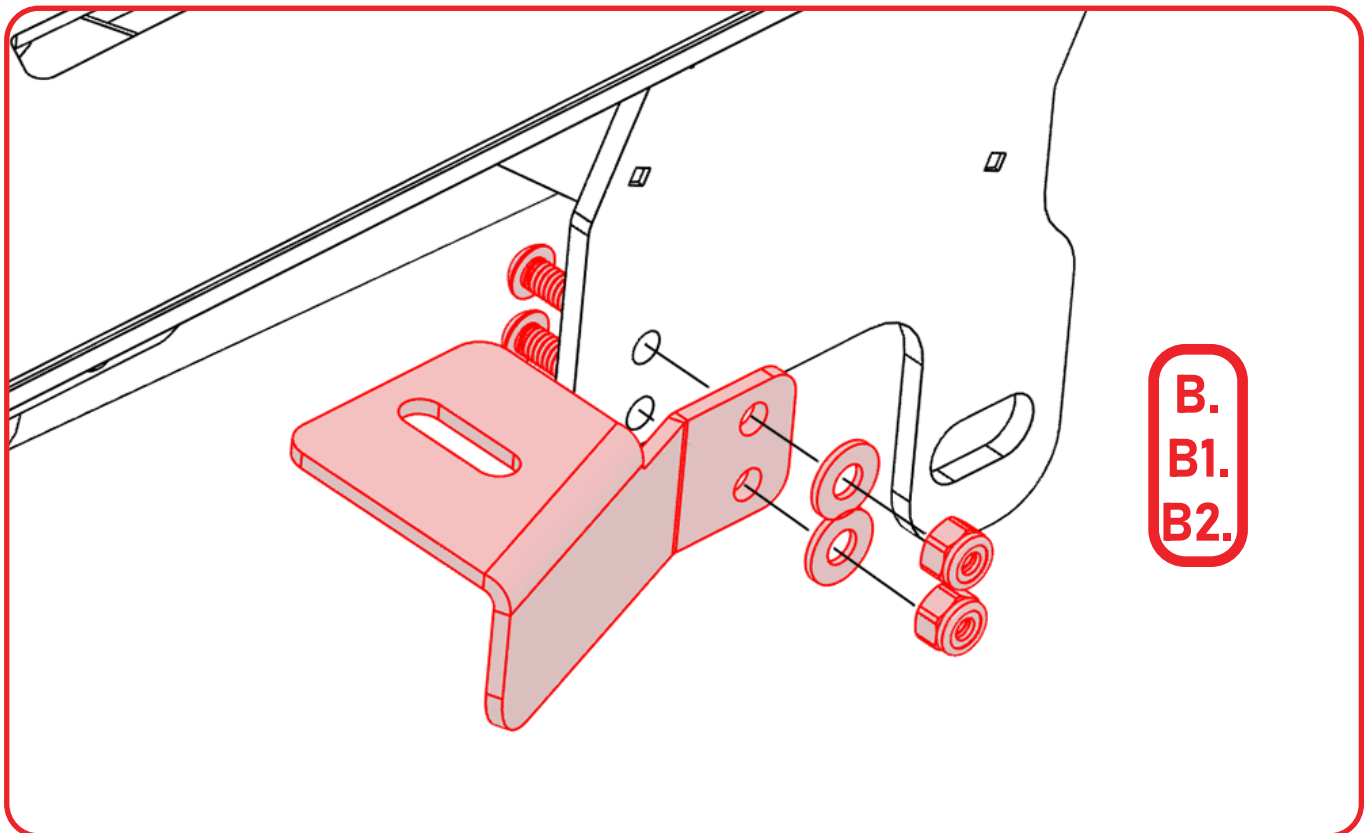

RACE SERIES DOVETAIL REAR BUMPER 21-UP/FORD F-150 RAPTOR

INSTALL

□ STEP 12

Measure from the bottom of the bed panel down 3" and mark a line as shown on FIG 1. Next, from the radius point on the fender shown in FIG 2 mark a line from the radius to the mark made on FIG. 1. ****This step is a preferred method, but if you would like to do your own measurements, fit the bumper to the truck before marking and cutting****

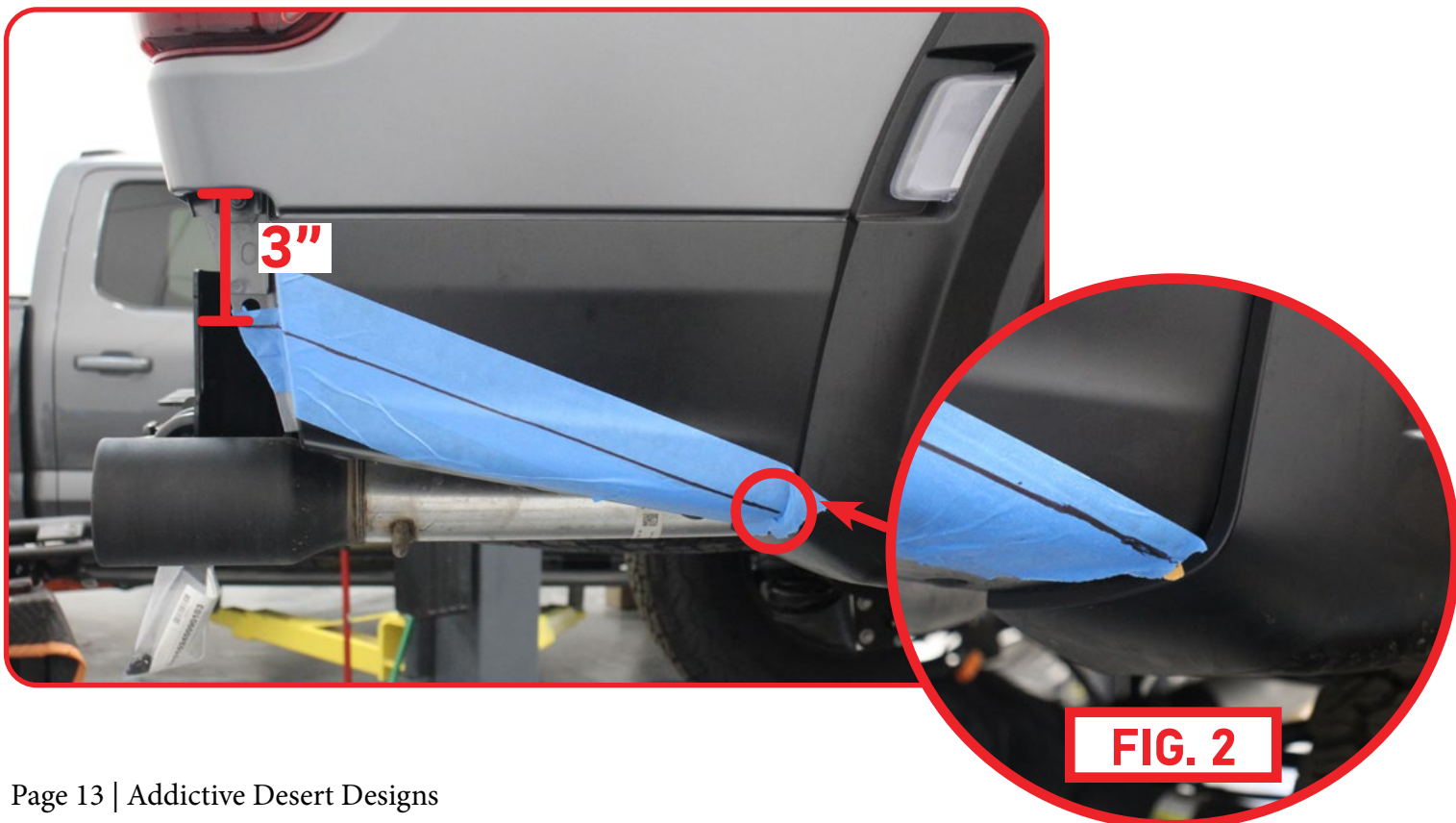
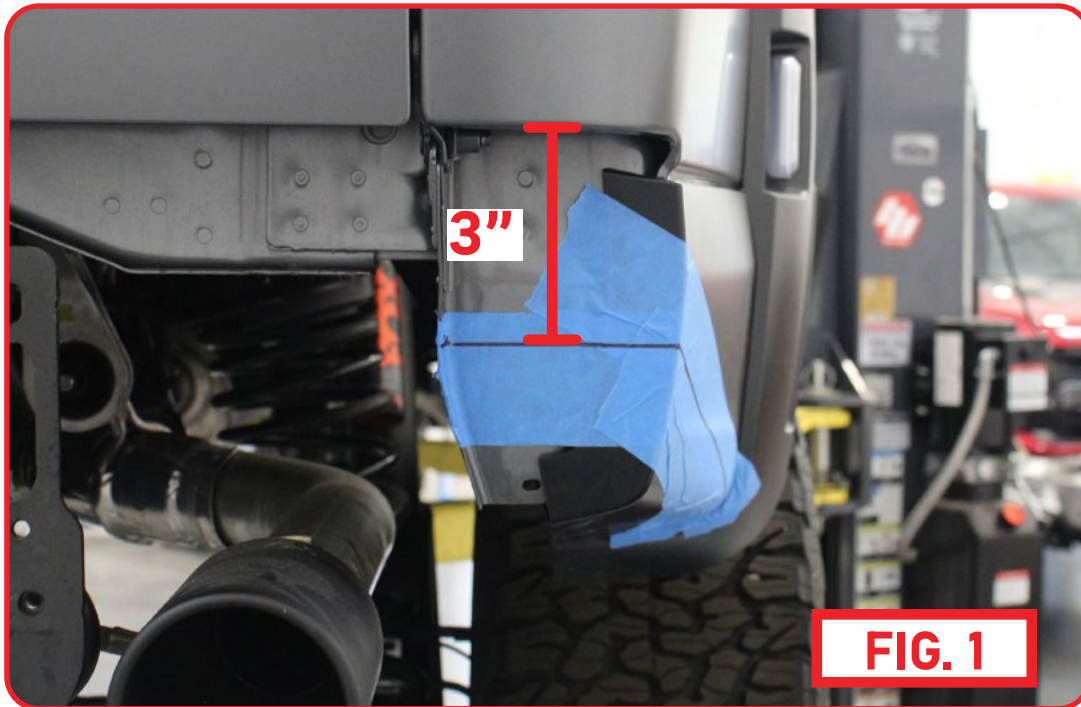

RACE SERIES DOVETAIL REAR BUMPER 21-UP/FORD F-150 RAPTOR

INSTALL

□ STEP 13

With your choice of cutting tool, cut the line made on **step 12** as shown below.

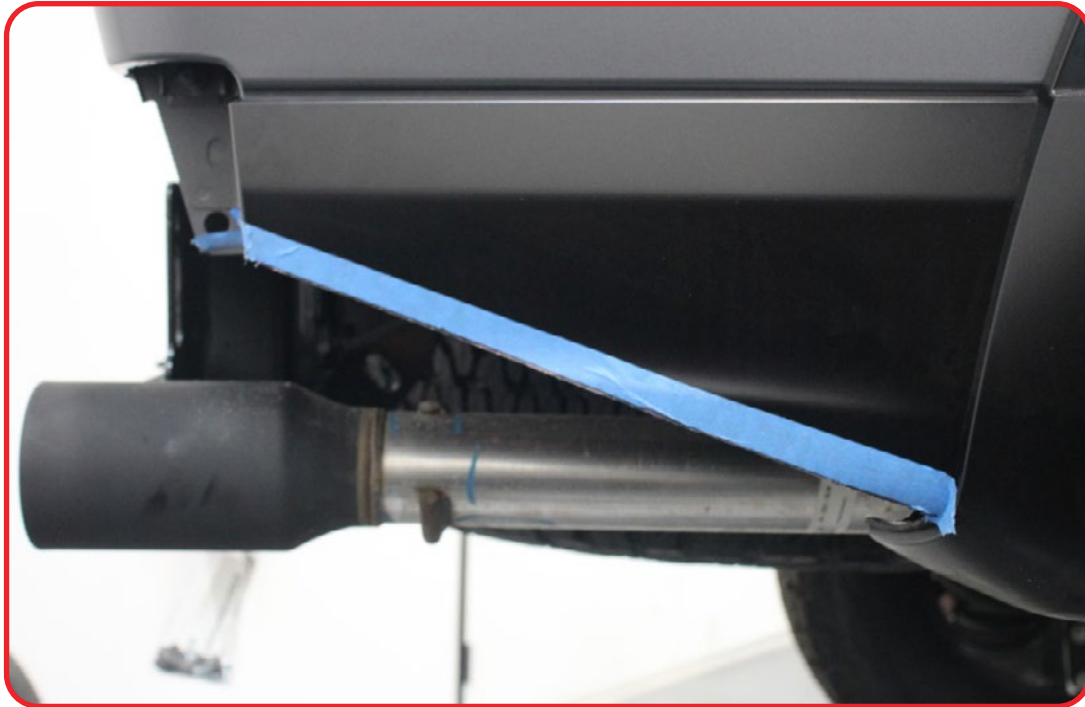



INSTALLATION GUIDE

RACE SERIES DOVETAIL REAR BUMPER 21-UP/FORD F-150 RAPTOR

INSTALL

□ STEP 14

Using a (T40 torx) install your new ADD bumper using the OEM hardware from the bottom mount you removed on step 6.

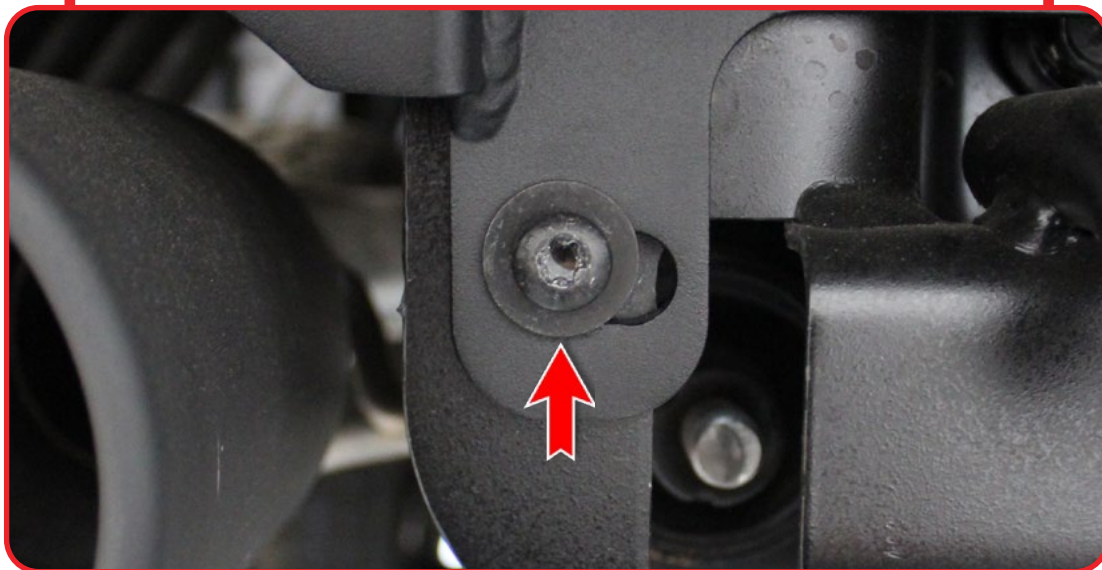



INSTALLATION GUIDE

RACE SERIES DOVETAIL REAR BUMPER 21-UP/FORD F-150 RAPTOR

INSTALL

□ STEP 15

Install the provided (A, A1, A2) 3/8" hardware using a (9/16 socket) and a (9/16 wrench) for the top mounting holes.





INSTALLATION GUIDE

RACE SERIES DOVETAIL REAR BUMPER 21-UP/FORD F-150 RAPTOR

INSTALL

STEP 16

Install the license plate with the provided (C, C1) hardware as shown below using a (flat head).

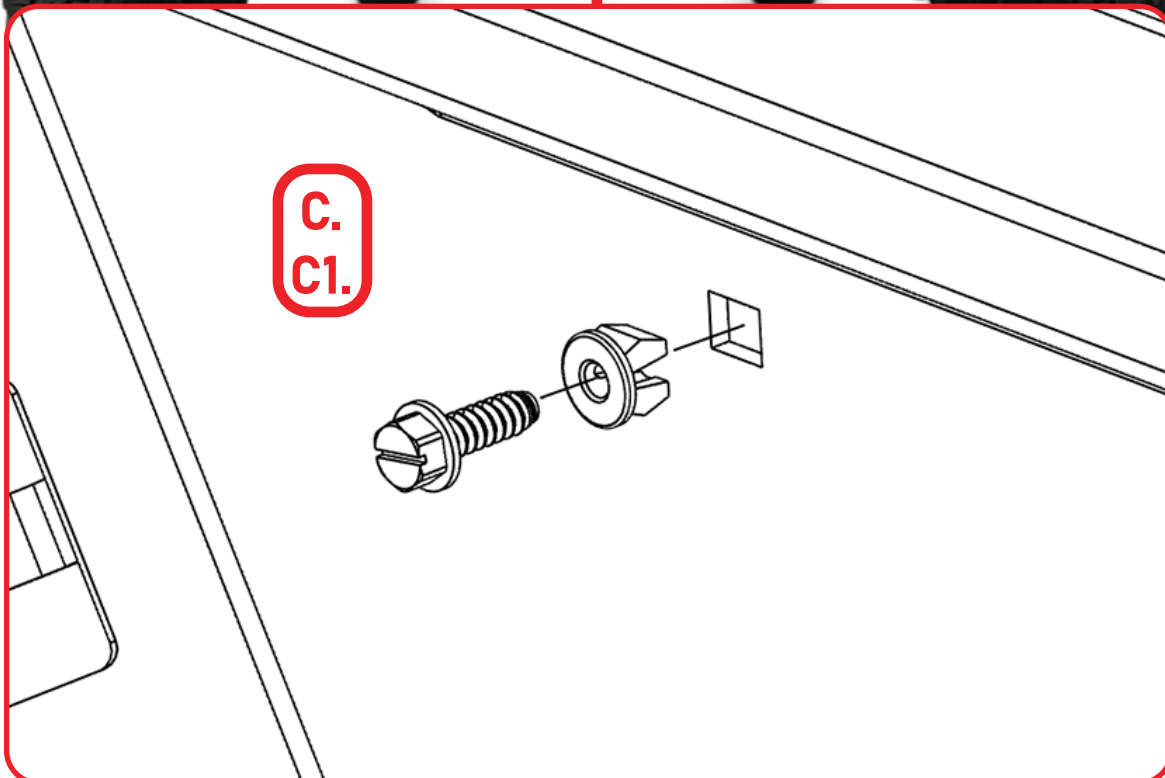

RACE SERIES DOVETAIL REAR BUMPER 21-UP/FORD F-150 RAPTOR

INSTALL

□ STEP 17

Plug in the wire harness, and reinstall the ground using a (10mm). ****Ensure the clip is fully pushed down when plugged in as shown below****

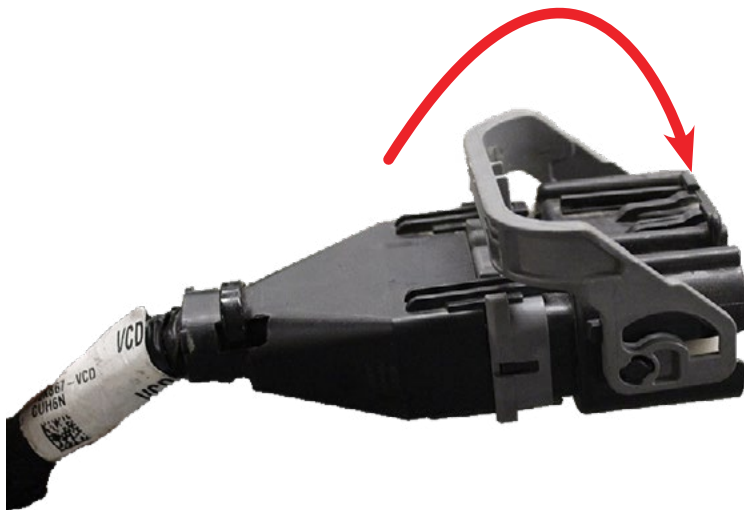
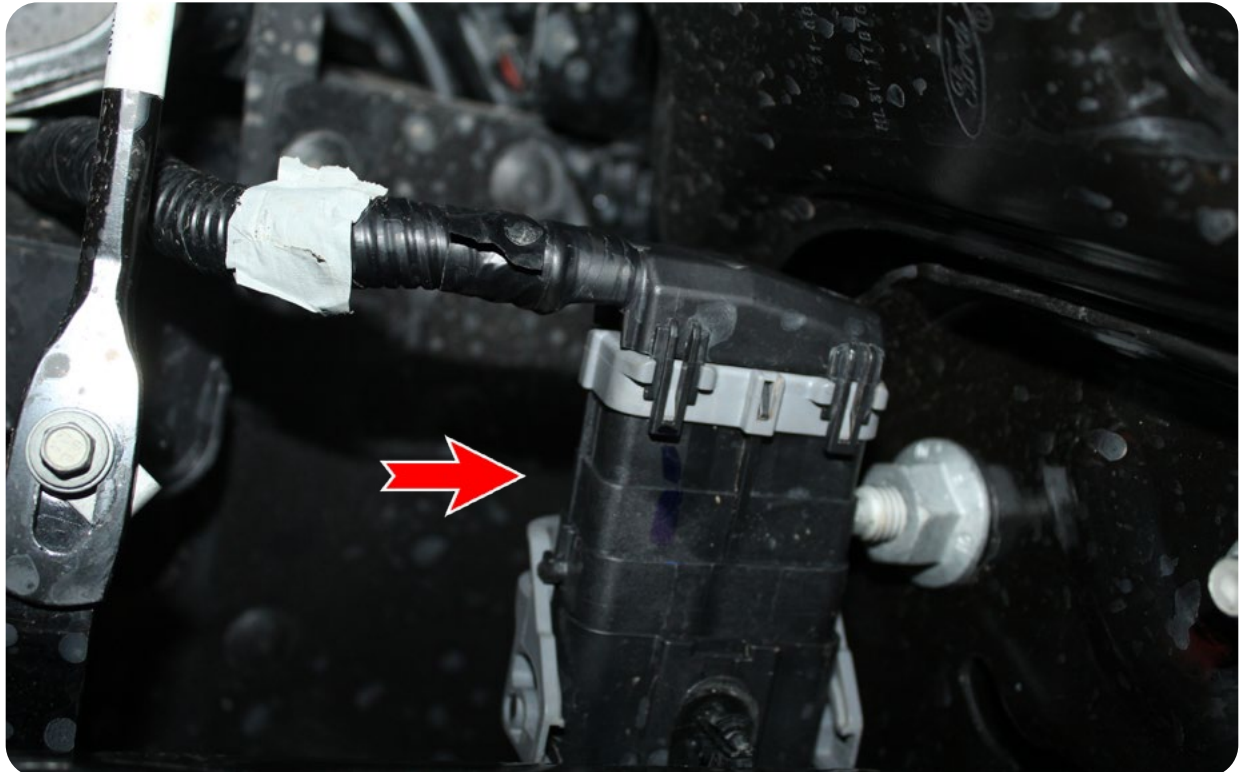



INSTALLATION GUIDE

RACE SERIES DOVETAIL REAR BUMPER 21-UP/FORD F-150 RAPTOR

FINAL

STEP 18

Stand back and enjoy your new ADD Race Series Dovetail Rear Bumper.

Check and re-tighten, all mounting bolts after 100 miles and periodically thereafter.



THIS PRODUCT IS PROTECTED BY ONE OR MORE U.S. PATENTS
WWW.ADDICTIVEDESERTDESIGNS.COM/PATENTS

FOR ADDITIONAL SUPPORT OR TECHNICAL QUESTIONS,
PLEASE CALL 480-671-0820 OR
EMAIL INFO@ADDICTIVEDESERTDESIGNS.COM