



INSTALLATION GUIDE

2023-UP/CHEVY COLORADO ZR2

PHANTOM REAR BUMPER

F580195090103



TOOLS REQUIRED

(Allen) 5/32, 7/32

(Wrench) 7mm, 18mm, 21mm, 7/16, 9/16

(Socket) 7mm, 18mm, 21mm, 7/16, 9/16

Ratchet

Flat Head/Fastener Remover



TIME REQUIRED

- 2 hours for OEM Removal/Bumper Install

-1 Additional Hour to Wire Lights

****Labor Rates are based on a vehicle with no pre-existing damage. Wiring labor is based on a standard wiring procedure with light switches installed in an easily accessible location. Custom light triggering or switch mounting location will result in a greater labor charge.****



SKILL LEVEL

-Easy/Intermediate

****This installation requires 2 people for best results****

⚠️ WARNINGS/CAUTIONS BEFORE STARTING INSTALLATION ⚠️

-BEFORE YOU INSTALL THIS KIT-

Read and understand all instructions,

warnings, cautions, & notes contained in this installation instruction guide. Consult your vehicle owner's manual for proper disconnection of electrical and lifting of vehicle if required for installation of this product.

This install may require some technical skills and knowledge of basic mechanical work. If you do not feel that you are capable of performing this install please take this product to a trained professional.

After reading this guide please contact us with any questions or concerns before installing product.

Customer Service (480) 671-0820

Addictive desert designs is not responsible for any bodily injury or harm to you or your vehicle as a result of an improper install.

Proper installation of this kit required knowledge of the factory recommended procedures for removal and installation of original equipment components.

We recommend that the factory shop manual and any special tools needed to service your vehicle be on hand during the installation. Installation of this kit without proper knowledge of the factory recommended procedures may affect the performance of these

components and the safety of the vehicle.

Inspect all contents of this package to make sure product is not damaged and all installation hardware has been included. If parts are missing from kit, please be prepared to provide the following information:

1. Name of purchase location
2. Bar Code on side of box
3. Date above bar code
4. Date inside box cover

ALWAYS WEAR EYE PROTECTION WHEN OPERATING POWER TOOLS



INSTALLATION GUIDE

PHANTOM REAR BUMPER 2023-UP/CHEVY COLORADO ZR2

REMOVAL

□ STEP 1

Unplug the main wire harness and rear camera plug in located on the driver side on the frame rail.





INSTALLATION GUIDE

PHANTOM REAR BUMPER 2023-UP/CHEVY COLORADO ZR2

REMOVAL

□ STEP 2

Unplug the 2x plug ins located behind the license plate.

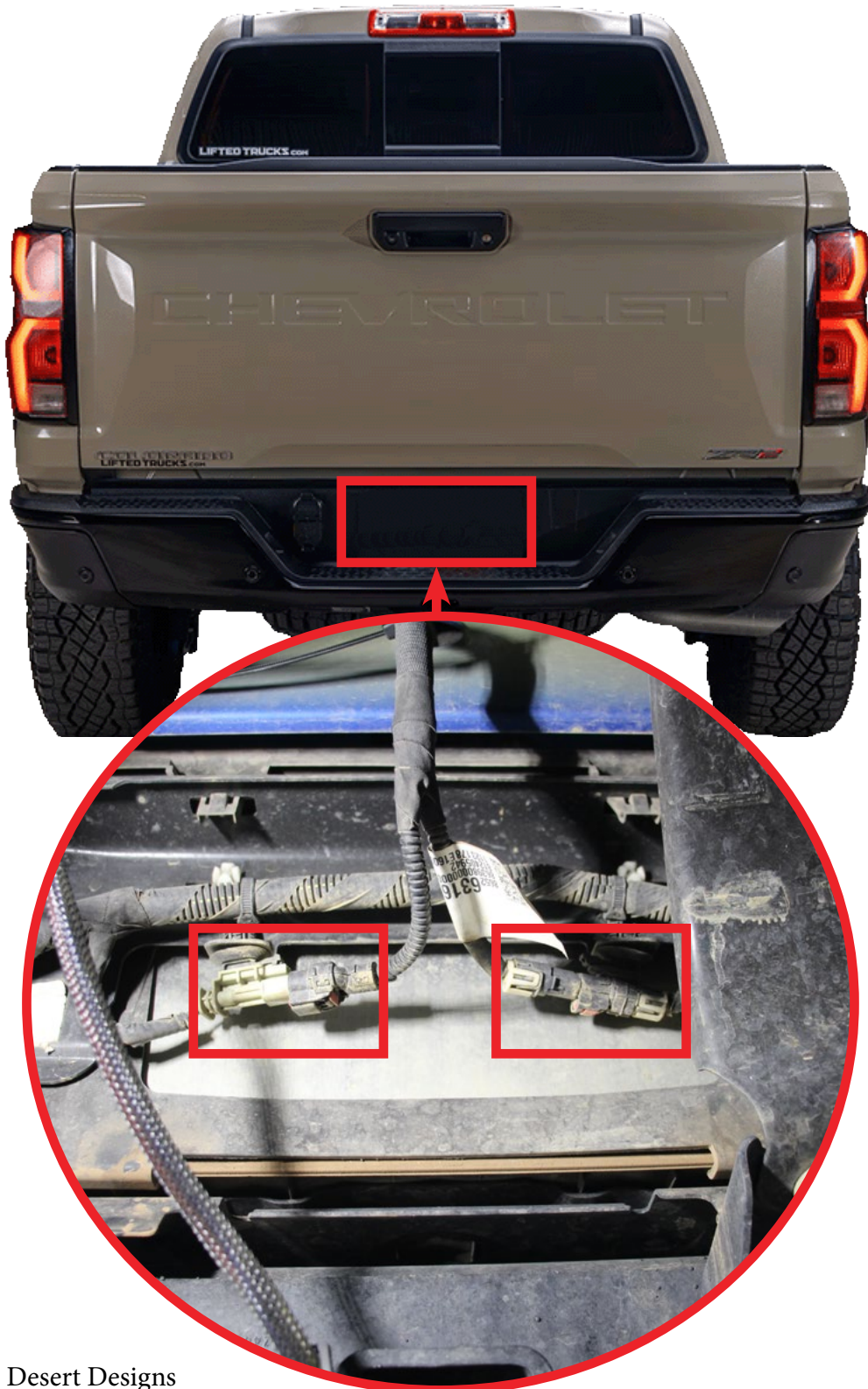



INSTALLATION GUIDE

PHANTOM REAR BUMPER 2023-UP/CHEVY COLORADO ZR2

REMOVAL

□ STEP 3

Unplug the trailer plug.

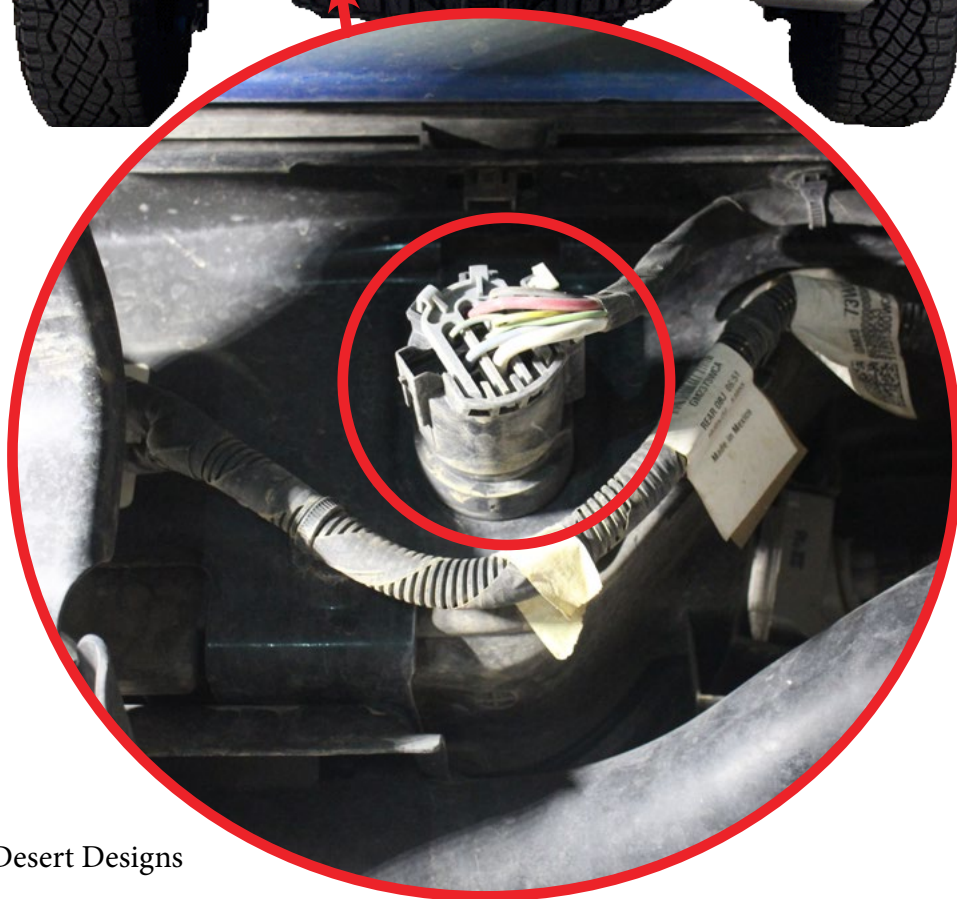



INSTALLATION GUIDE

PHANTOM REAR BUMPER 2023-UP/CHEVY COLORADO ZR2

REMOVAL

□ STEP 4

Using a (21mm socket), remove the 2x bolts per side holding the bumper to the hitch as shown below. ****Keep Hardware****



PHANTOM REAR BUMPER 2023-UP/CHEVY COLORADO ZR2

REMOVAL

□ STEP 5

Using a (18mm socket), remove the mounting hardware located on both driver and passenger side.



PHANTOM REAR BUMPER 2023-UP/CHEVY COLORADO ZR2

REMOVAL

□ STEP 6

Using a (7mm socket), Remove the license plate lights.

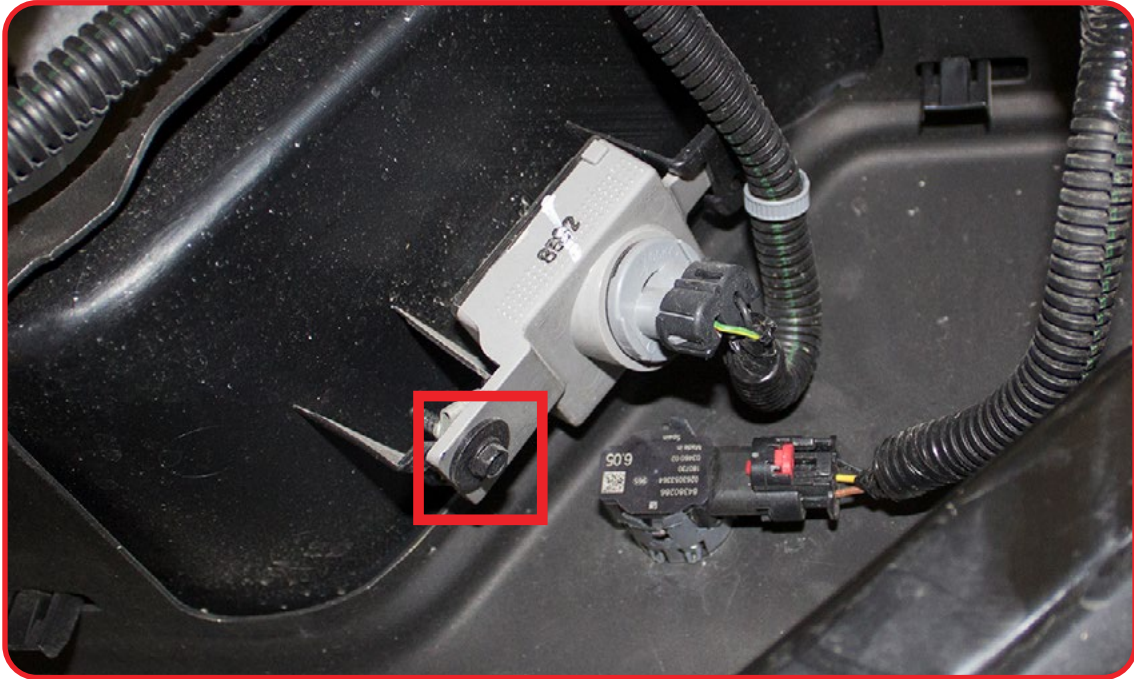

□ STEP 7

Remove the parking sensors from the bezels by spreading the tabs and pulling out. ****CAUTION: Sensor bezels are fragile****

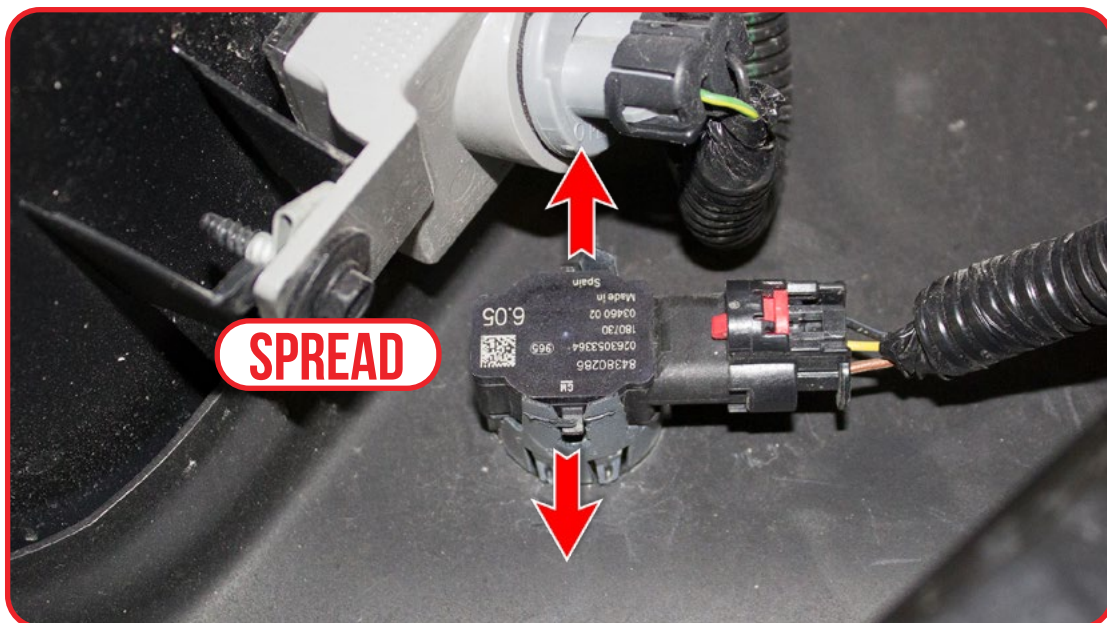

PHANTOM REAR BUMPER 2023-UP/CHEVY COLORADO ZR2

REMOVAL

□ STEP 8

Remove the sensor bezels by pushing the tabs in and sliding out of the cutout. Remember the orientation of each sensor.

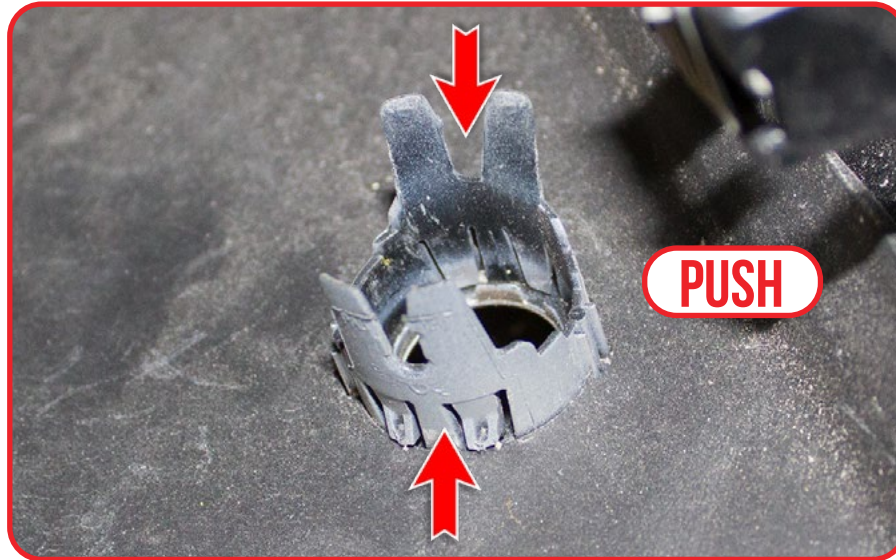

□ STEP 9

Using a (7mm socket), remove the blind spot sensor bracket.

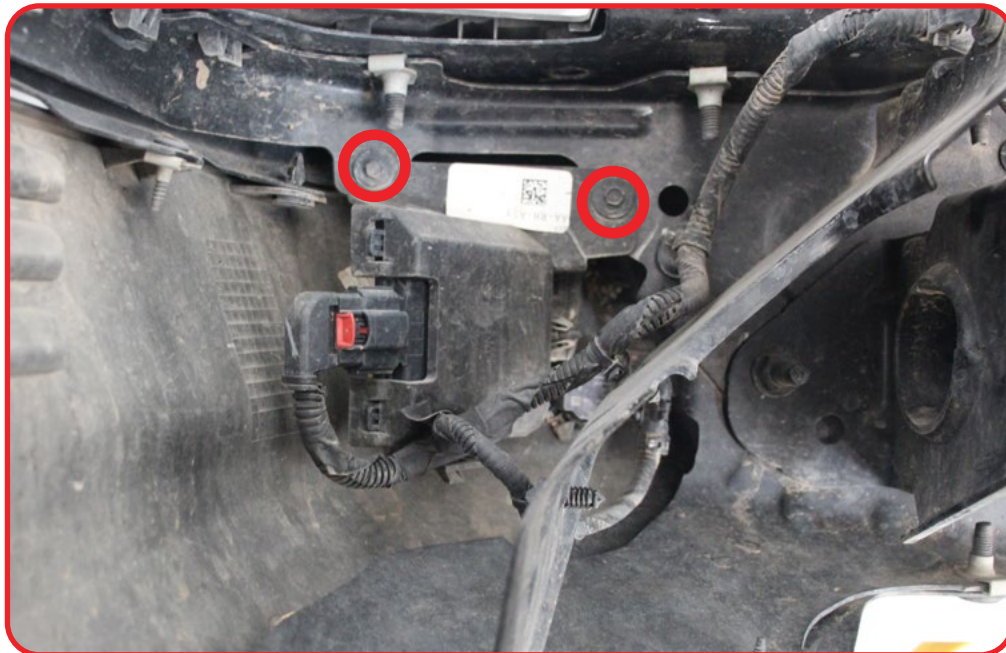

PHANTOM REAR BUMPER 2023-UP/CHEVY COLORADO ZR2

REMOVAL

□ STEP 10

Using a (7mm socket), remove the bolt highlighted below.

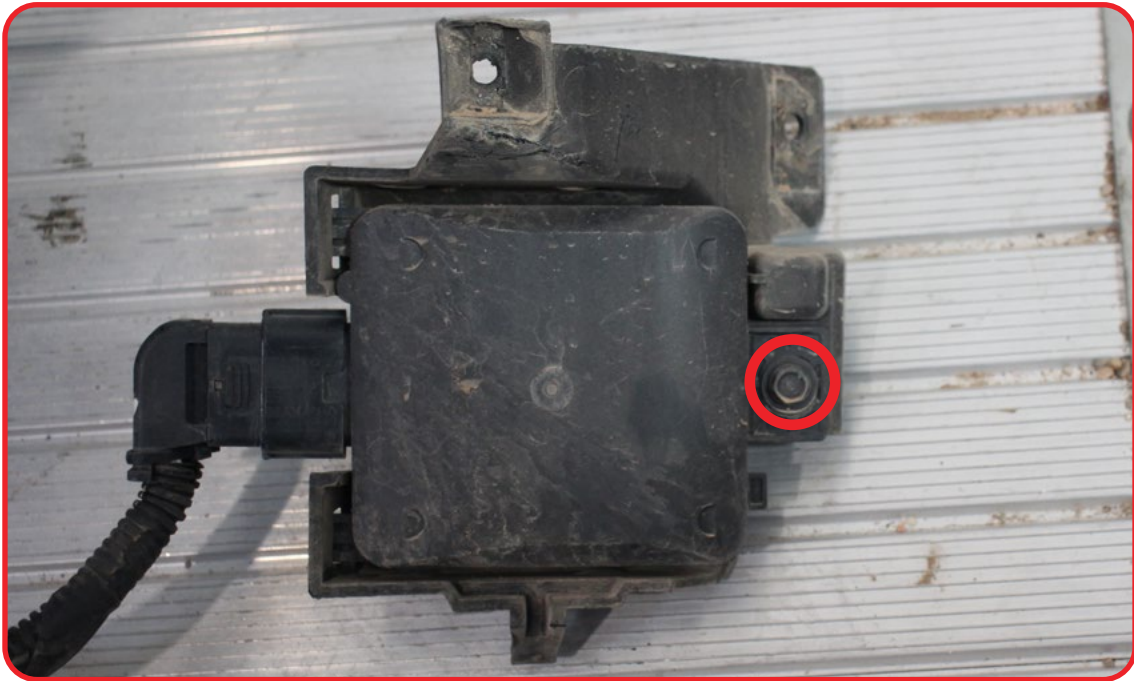

□ STEP 11

Remove the trailer plug on the backside of the bumper using a (flathead screwdriver) to release clips.



PHANTOM REAR BUMPER 2023-UP/CHEVY COLORADO ZR2

INSTALL

□ STEP 12

Using a (21mm socket), Install the provided brackets onto the hitch as shown below.

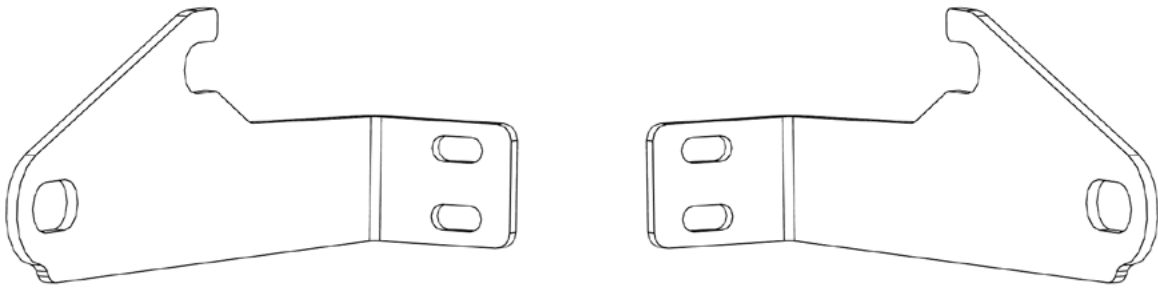

PHANTOM REAR BUMPER 2023-UP/CHEVY COLORADO ZR2

INSTALL

□ STEP 13

With the provided 7/16 hardware, install the license plate lights using a (7/16 wrench) and a (5/32 allen).

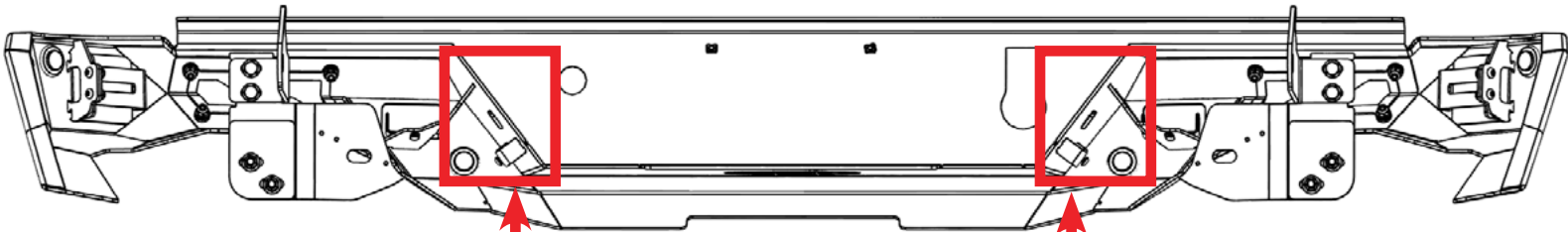

PHANTOM REAR BUMPER 2023-UP/CHEVY COLORADO ZR2

INSTALL

□ STEP 14

Install the sensor bezels in the correct orientations and remove the plastic retainers as shown below before installing the sensors into the bezels. Next install the sensors into the bezels.

****CAUTION: Bezels are fragile install with care****

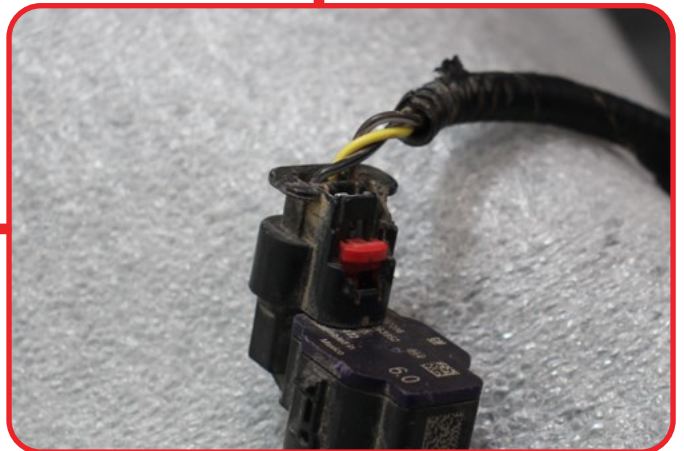
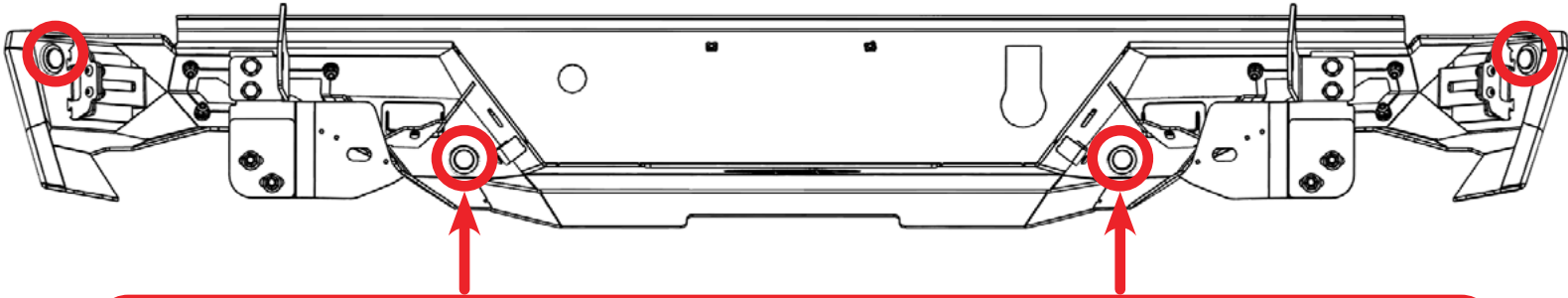



INSTALLATION GUIDE

PHANTOM REAR BUMPER
2023-UP/CHEVY COLORADO ZR2

INSTALL



PHANTOM REAR BUMPER 2023-UP/CHEVY COLORADO ZR2

INSTALL

STEP 15

Install the blind spot sensors as shown below with the provided brackets and 7/16 hardware using a (7/16 wrench) and a (5/32 allen).

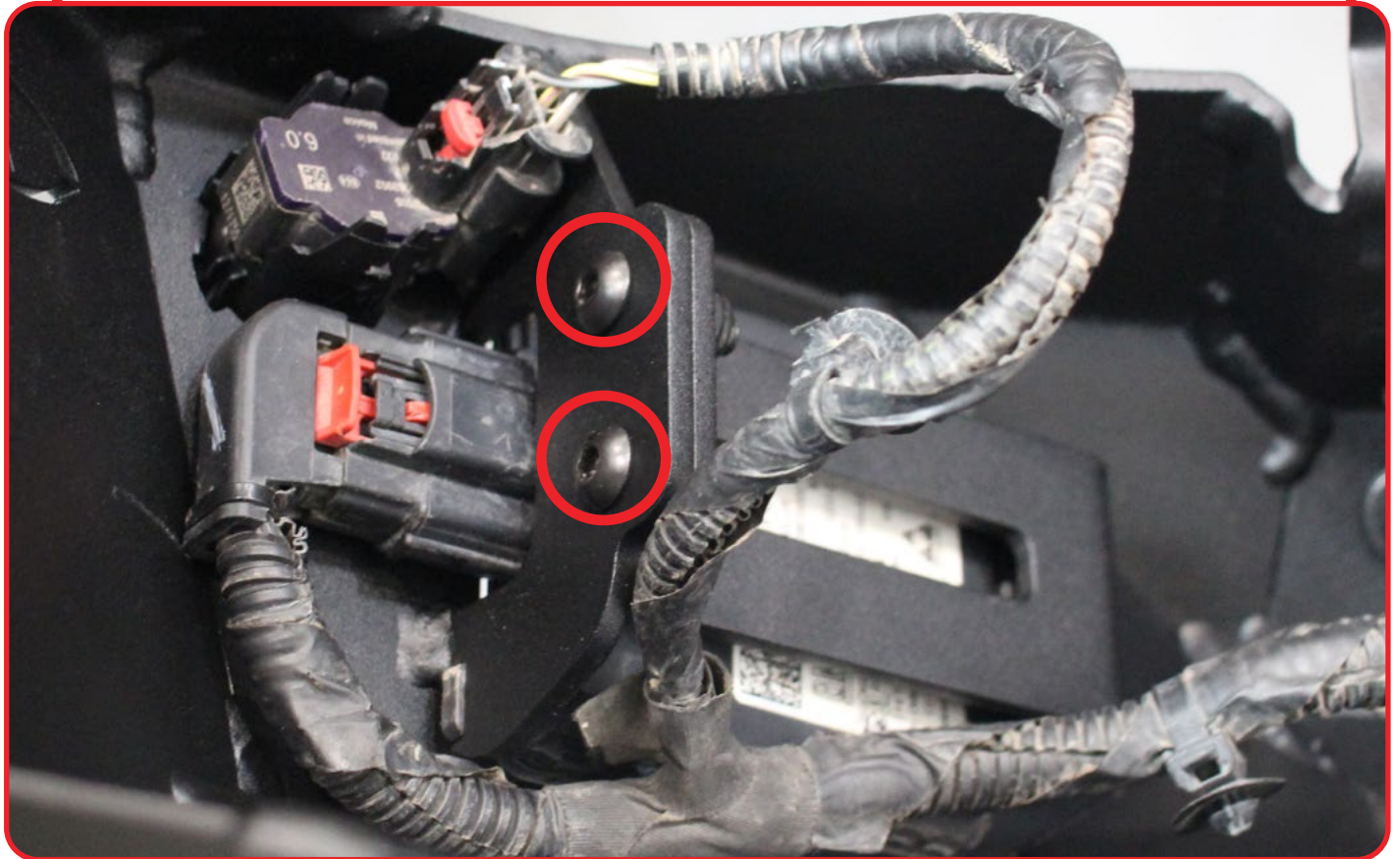
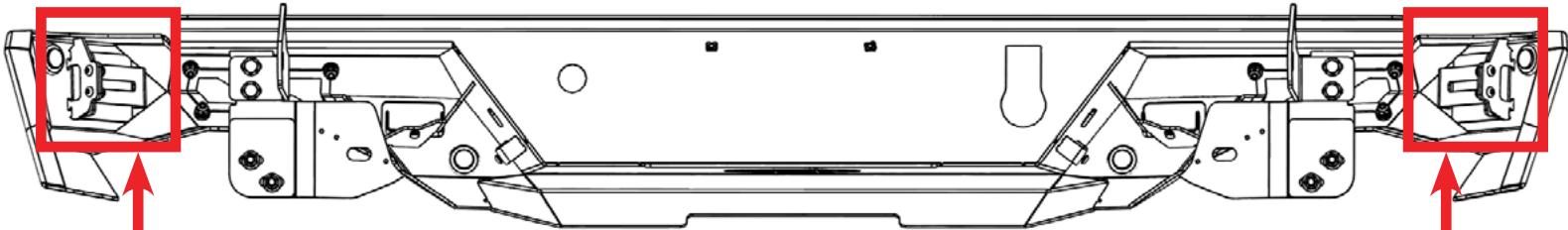



INSTALLATION GUIDE

PHANTOM REAR BUMPER 2023-UP/CHEVY COLORADO ZR2

INSTALL

- STEP 16**
Install the trailer plug.

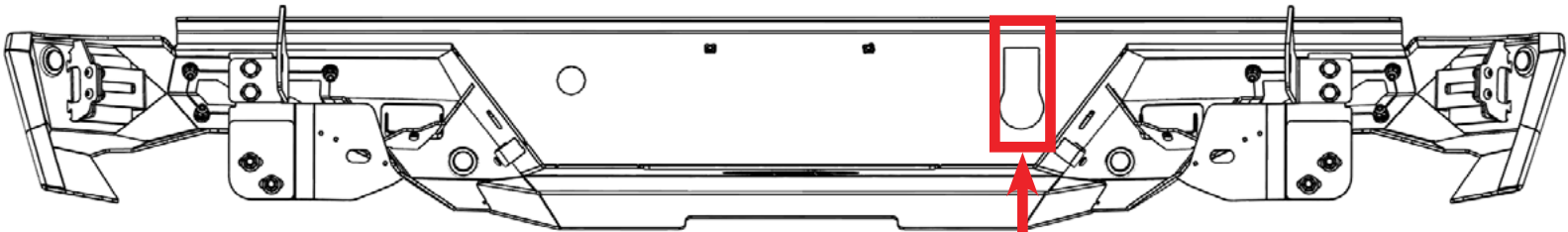

PHANTOM REAR BUMPER 2023-UP/CHEVY COLORADO ZR2

INSTALL

□ STEP 17

Install the provided nut clips as shown below onto the bumper.

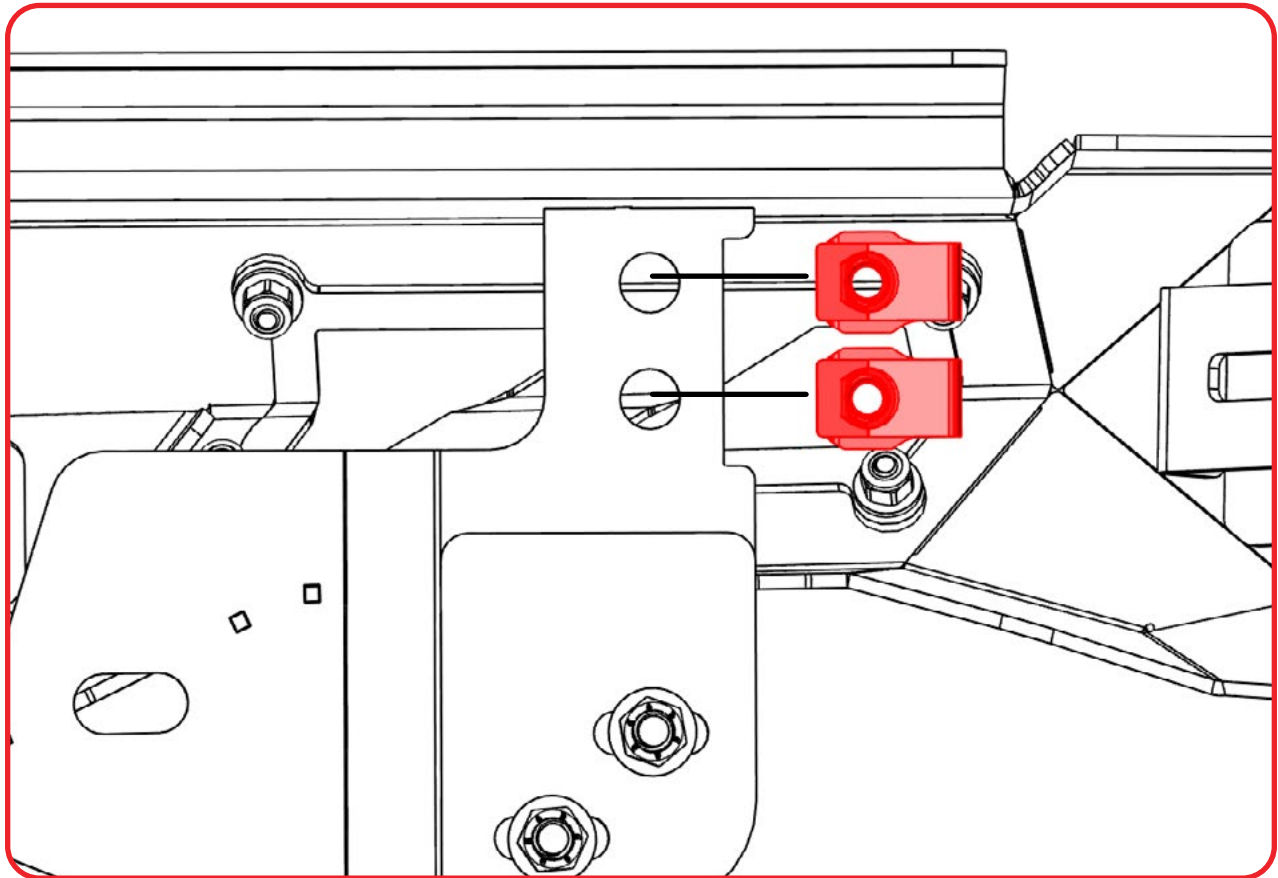
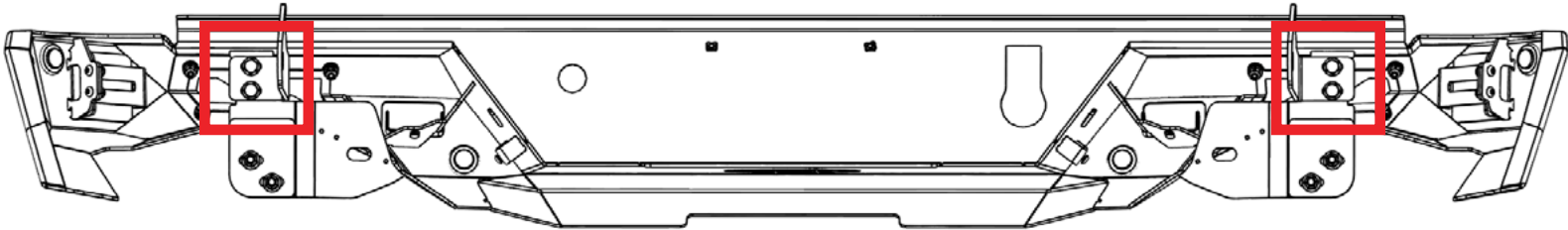



INSTALLATION GUIDE

PHANTOM REAR BUMPER 2023-UP/CHEVY COLORADO ZR2

INSTALL

□ STEP 18

With a helping hand, install the bumper with the provided 3/8 hardware using a (9/16 wrench) and a (7/32 allen).





INSTALLATION GUIDE

PHANTOM REAR BUMPER 2023-UP/CHEVY COLORADO ZR2

INSTALL

□ STEP 19

Install the provided 3/8 hardware as shown below using a (9/16 socket).





INSTALLATION GUIDE

PHANTOM REAR BUMPER 2023-UP/CHEVY COLORADO ZR2

INSTALL

□ STEP 20

Plug in the main harness and all other plugs removed from steps 1-3.





INSTALLATION GUIDE

PHANTOM REAR BUMPER 2023-UP/CHEVY COLORADO ZR2

FINAL

□ STEP 21

Stand back and enjoy your new ADD Phantom Rear Bumper.

Check and re-tighten all mounting bolts after 100 miles and periodically thereafter.



THIS PRODUCT IS PROTECTED BY ONE OR MORE U.S. PATENTS
WWW.ADDICTIVEDESERTDESIGNS.COM/PATENTS

FOR ADDITIONAL SUPPORT OR TECHNICAL QUESTIONS,
PLEASE CALL 480-671-0820 OR
EMAIL INFO@ADDICTIVEDESERTDESIGNS.COM